

IM-945GSE Series

MS-9830 (V1.X) Mainboard



Copyright Notice

The material in this document is the intellectual property of **MICRO-STAR INTERNATIONAL**. We take every care in the preparation of this document, but no guarantee is given as to the correctness of its contents. Our products are under continual improvement and we reserve the right to make changes without notice.

Trademarks

All trademarks are the properties of their respective owners.

Intel® and Pentium® are registered trademarks of Intel Corporation.

AMD, Athlon™, Athlon™ XP, Thoroughbred™, and Duron™ are registered trademarks of AMD Corporation.

NVIDIA, the NVIDIA logo, DualNet, and nForce are registered trademarks or trademarks of NVIDIA Corporation in the United States and/or other countries.

PS/2 and OS®/2 are registered trademarks of International Business Machines Corporation.

Windows® 98/2000/NT/XP/Vista are registered trademarks of Microsoft Corporation.

Netware® is a registered trademark of Novell, Inc.

Award® is a registered trademark of Phoenix Technologies Ltd.

AMI® is a registered trademark of American Megatrends Inc.

Revision History

Revision	Revision History	Date
V1.1	Adding option D, E mainboards	January 2009

Technical Support

If a problem arises with your system and no solution can be obtained from the user's manual, please contact your place of purchase or local distributor. Alternatively, please try the following help resources for further guidance.

- 🔍 Visit the MSI website at <http://global.msi.com.tw/index.php?func=service> for FAQ, technical guide, BIOS updates, driver updates, and other information.
- 📞 Contact our technical staff at <http://ocss.msi.com.tw>.

Safety Instructions

1. Always read the safety instructions carefully.
2. Keep this User's Manual for future reference.
3. Keep this equipment away from humidity.
4. Lay this equipment on a reliable flat surface before setting it up.
5. The openings on the enclosure are for air convection hence protects the equipment from overheating. **DO NOT COVER THE OPENINGS.**
6. Make sure the voltage of the power source and adjust properly 110/220V before connecting the equipment to the power inlet.
7. Place the power cord such a way that people can not step on it. Do not place anything over the power cord.
8. Always Unplug the Power Cord before inserting any add-on card or module.
9. All cautions and warnings on the equipment should be noted.
10. Never pour any liquid into the opening that could damage or cause electrical shock.
11. If any of the following situations arises, get the equipment checked by service personnel:
 - ▶ The power cord or plug is damaged.
 - ▶ Liquid has penetrated into the equipment.
 - ▶ The equipment has been exposed to moisture.
 - ▶ The equipment does not work well or you can not get it work according to User's Manual.
 - ▶ The equipment has dropped and damaged.
 - ▶ The equipment has obvious sign of breakage.
12. **DO NOT LEAVE THIS EQUIPMENT IN AN ENVIRONMENT UNCONDITIONED, STORAGE TEMPERATURE ABOVE 60°C (140°F), IT MAY DAMAGE THE EQUIPMENT.**



CAUTION: Danger of explosion if battery is incorrectly replaced. Replace only with the same or equivalent type recommended by the manufacturer.



警告使用者：

此為甲類資訊技術設備，於居住環境中使用時，可能會造成射頻擾動，在此情況下，使用者會被要求採取某些適當的對策



廢電池請回收

For better environmental protection, waste batteries should be collected separately for recycling or special disposal.

FCC-B Radio Frequency Interference Statement

This equipment has been tested and found to comply with the limits for a Class B digital device, pursuant to Part



15 of the FCC Rules. These limits are designed to provide reasonable protection against harmful interference in a residential installation. This equipment generates, uses and can radiate radio frequency energy and, if not installed and used in accordance with the instructions, may cause harmful interference to radio communications. However, there is no guarantee that interference will not occur in a particular installation. If this equipment does cause harmful interference to radio or television reception, which can be determined by turning the equipment off and on, the user is encouraged to try to correct the interference by one or more of the measures listed below.

- ▶ Reorient or relocate the receiving antenna.
- ▶ Increase the separation between the equipment and receiver.
- ▶ Connect the equipment into an outlet on a circuit different from that to which the receiver is connected.
- ▶ Consult the dealer or an experienced radio/television technician for help.

Notice 1

The changes or modifications not expressly approved by the party responsible for compliance could void the user's authority to operate the equipment.

Notice 2

Shielded interface cables and A.C. power cord, if any, must be used in order to comply with the emission limits.

VOIR LANOTICE D'INSTALLATIONAVANT DE RACCORDER AU RESEAU.



This device complies with Part 15 of the FCC Rules. Operation is subject to the following two conditions:

- (1) this device may not cause harmful interference, and*
- (2) this device must accept any interference received, including interference that may cause undesired operation.*

WEEE (Waste Electrical and Electronic Equipment) Statement



ENGLISH

To protect the global environment and as an environmentalist, MSI must remind you that...

Under the European Union ("EU") Directive on Waste Electrical and Electronic Equipment, Directive 2002/96/EC, which takes effect on August 13, 2005, products of "electrical and electronic equipment" cannot be discarded as municipal waste anymore and manufacturers of covered electronic equipment will be obligated to take back such products at the end of their useful life. MSI will comply with the product take back requirements at the end of life of MSI-branded products that are sold into the EU. You can return these products to local collection points.

DEUTSCH

Hinweis von MSI zur Erhaltung und Schutz unserer Umwelt

Gemäß der Richtlinie 2002/96/EG über Elektro- und Elektronik-Altgeräte dürfen Elektro- und Elektronik-Altgeräte nicht mehr als kommunale Abfälle entsorgt werden. MSI hat europaweit verschiedene Sammel- und Recyclingunternehmen beauftragt, die in die Europäische Union in Verkehr gebrachten Produkte, am Ende seines Lebenszyklus zurückzunehmen. Bitte entsorgen Sie dieses Produkt zum gegebenen Zeitpunkt ausschliesslich an einer lokalen Altgerätesammelstelle in Ihrer Nähe.

FRANÇAIS

En tant qu'écologiste et afin de protéger l'environnement, MSI tient à rappeler ceci...

Au sujet de la directive européenne (EU) relative aux déchets des équipement électriques et électroniques, directive 2002/96/EC, prenant effet le 13 août 2005, que les produits électriques et électroniques ne peuvent être déposés dans les décharges ou tout simplement mis à la poubelle. Les fabricants de ces équipements seront obligés de récupérer certains produits en fin de vie. MSI prendra en compte cette exigence relative au retour des produits en fin de vie au sein de la communauté européenne. Par conséquent vous pouvez retourner localement ces matériels dans les points de collecte.

РУССКИЙ

Компания MSI предпринимает активные действия по защите окружающей среды, поэтому напоминаем вам, что...

В соответствии с директивой Европейского Союза (ЕС) по предотвращению загрязнения окружающей среды использованным электрическим и электронным оборудованием (директива WEEE 2002/96/EC), вступающей в силу 13 августа 2005 года, изделия, относящиеся к электрическому и электронному оборудованию, не могут рассматриваться как бытовой мусор, поэтому производители вышеперечисленного электронного оборудования обязаны принимать его для переработки по окончании срока службы. MSI обязуется соблюдать требования по приему продукции, проданной под маркой MSI на территории ЕС, в переработку по окончании срока службы. Вы можете вернуть эти изделия в специализированные пункты приема.

ESPAÑOL

MSI como empresa comprometida con la protección del medio ambiente, recomienda:

Bajo la directiva 2002/96/EC de la Unión Europea en materia de desechos y/o equipos electrónicos, con fecha de rigor desde el 13 de agosto de 2005, los productos clasificados como "eléctricos y equipos electrónicos" no pueden ser depositados en los contenedores habituales de su municipio, los fabricantes de equipos electrónicos, están obligados a hacerse cargo de dichos productos al término de su período de vida. MSI estará comprometido con los términos de recogida de sus productos vendidos en la Unión Europea al final de su período de vida. Usted debe depositar estos productos en el punto limpio establecido por el ayuntamiento de su localidad o entregar a una empresa autorizada para la recogida de estos residuos.

NEDERLANDS

Om het milieu te beschermen, wil MSI u eraan herinneren dat....

De richtlijn van de Europese Unie (EU) met betrekking tot Vervuiling van Elektrische en Electronische producten (2002/96/EC), die op 13 Augustus 2005 in zal gaan kunnen niet meer beschouwd worden als vervuiling.

Fabrikanten van dit soort producten worden verplicht om producten retour te nemen aan het eind van hun levenscyclus. MSI zal overeenkomstig de richtlijn handelen voor de producten die de merknaam MSI dragen en verkocht zijn in de EU. Deze goederen kunnen geretourneerd worden op lokale inzamelingspunten.

SRPSKI

Da bi zaštitili prirodnu sredinu, i kao preduzeće koje vodi računa o okolini i prirodnoj sredini, MSI mora da vas podesti da...

Po Direktivi Evropske unije ("EU") o odbačenju elektonskoj i električnoj opremi, Direktiva 2002/96/EC, koja stupa na snagu od 13. Avgusta 2005, proizvodi koji spadaju pod "elektonsku i električnu opremu" ne mogu više biti odbačeni kao običan otpad i proizvođači ove opreme biće prinudeni da uzmu natrag ove proizvode na kraju njihovog uobičajenog veka trajanja. MSI će poštovati zahtev o preuzimanju ovakvih proizvoda kojima je istekao vek trajanja, koji imaju MSI oznaku i koji su prodati u EU. Ove proizvode možete vratiti na lokalnim mestima za prikupljanje.

POLSKI

Aby chronić nasze środowisko naturalne oraz jako firma dbająca o ekologię, MSI przypomina, że...

Zgodnie z Dyrektywą Unii Europejskiej ("UE") dotyczącą odpadów produktów elektrycznych i elektronicznych (Dyrektywa 2002/96/EC), która wchodzi w życie 13 sierpnia 2005, tzw. "produkty oraz wyposażenie elektryczne i elektroniczne" nie mogą być traktowane jako śmieć komunalne, tak więc producenci tych produktów będą zobowiązani do odbierania ich w momencie gdy produkt jest wycofywany z użycia. MSI wypełni wymagania UE, przyjmując produkty (sprzedawane na terenie Unii Europejskiej) wycofywane z użycia. Produkty MSI będzie można zwracać w wyznaczonych punktach zbiorczych.

TÜRKÇE

Çevreci özelliğiyle bilinen MSI dünyada çevreyi korumak için hatırlatır:

Avrupa Birliği (AB) Kararnamesi Elektrik ve Elektronik Malzeme Atığı, 2002/96/EC Kararnamesi altında 13 Ağustos 2005 tarihinden itibaren geçerli olmak üzere, elektrikli ve elektronik malzemeler diğer atıklar gibi çöpe atılmayacak ve bu elektronik cihazların üreticileri, cihazların kullanım süreleri bittikten sonra ürünleri geri toplamakla yükümlü olacaktır. Avrupa Birliği'ne satılan MSI markalı ürünlerin kullanım süreleri bittiğinde MSI ürünlerin geri alınması isteği ile işbirliği içerisinde olacaktır. Ürünlerinizi yerel toplama noktalarına bırakabilirsiniz.

ČESKY

Záleží nám na ochraně životního prostředí - společnost MSI upozorňuje...

Podle směrnice Evropské unie ("EU") o likvidaci elektrických a elektronických výrobků 2002/96/EC platné od 13. srpna 2005 je zakázáno likvidovat "elektrické a elektronické výrobky" v běžném komunálním odpadu a výrobci elektronických výrobků, na které se tato směrnice vztahuje, budou povinni odebírat takové výrobky zpět po skončení jejich životnosti. Společnost MSI splní požadavky na odebrání výrobků značky MSI, prodávaných v zemích EU, po skončení jejich životnosti. Tyto výrobky můžete odevzdat v místních sběrnách.

MAGYAR

Annak érdekében, hogy környezetünket megvédjük, illetve környezetvédőként fellépve az MSI emlékezteti Önt, hogy ...

Az Európai Unió („EU”) 2005. augusztus 13-án hatályba lépő, az elektromos és elektronikus berendezések hulladékairól szóló 2002/96/EK irányelve szerint az elektromos és elektronikus berendezések többé nem kezelhetők lakossági hulladékként, és az ilyen elektronikus berendezések gyártói kötelessé válnak az ilyen termékek visszavételére azok hasznos élettartama végén. Az MSI betartja a termékvisszavételrel kapcsolatos követelményeket az MSI márkánév alatt az EU-n belül értékesített termékek esetében, azok élettartamának végén. Az ilyen termékeket a legközelebbi gyűjtőhelyre viheti.

ITALIANO

Per proteggere l'ambiente, MSI, da sempre amica della natura, ti ricorda che....

In base alla Direttiva dell'Unione Europea (EU) sullo Smaltimento dei Materiali Elettrici ed Elettronici, Direttiva 2002/96/EC in vigore dal 13 Agosto 2005, prodotti appartenenti alla categoria dei Materiali Elettrici ed Elettronici non possono più essere eliminati come rifiuti municipali: i produttori di detti materiali saranno obbligati a ritirare ogni prodotto alla fine del suo ciclo di vita. MSI si adegnerà a tale Direttiva ritirando tutti i prodotti marchiati MSI che sono stati venduti all'interno dell'Unione Europea alla fine del loro ciclo di vita. È possibile portare i prodotti nel più vicino punto di raccolta.

CONTENTS

Copyright Notice	ii
Trademarks	ii
Revision History	ii
Technical Support	ii
Safety Instructions	iii
FCC-B Radio Frequency Interference Statement	iv
WEEE (Waste Electrical and Electronic Equipment) Statement	v
Chapter 1 Product Overview	1-1
Mainboard Specifications	1-2
Block Diagram	1-5
Mainboard Layout	1-6
Board Dimension	1-11
Back Panel & I/O Shield Drawing	1-12
Power Consumption	1-17
Safety Compliance & MTBF	1-19
Chapter 2 Hardware Setup	2-1
Quick Components Guide	2-2
Memory	2-3
Power Supply	2-4
Back Panel I/O	2-5
Connector	2-11
Jumper	2-19
Slot	2-20
Chapter 3 BIOS Setup	3-1
Entering Setup	3-2
The Menu Bar	3-4
Main	3-5
Advanced	3-6
Boot	3-17
Security	3-19
Chipset	3-20
Power	3-25
Exit	3-26
Chapter 4 System Resources	4-1
Watch Dog Timer Setting	4-2
AMI POST Code	4-3
Resource List	4-7

Chapter 1

Product Overview

Thank you for choosing the IM-945GSE Series (MS-9830 v1.X) Mini ITX mainboards from MSI.

Based on the innovative **Intel® 945GSE & ICH7M** controllers for optimal system efficiency, the IM-945GSE Series accommodate the latest Intel® Atom™ processor N270 (1.6GHz single core with HT) and support one DDR2 533/667/800 SO-DIMM slot to provide the maximum of 1GB memory capacity.

Three options are available for the IM-945GSE Series:

Option A	ATX Power, High Rear I/O, DVI, VGA, 1 RS-232/422/485 Port, 5 RS-232 Ports
Option B	DC Power, Low Rear I/O, DVI-I, 1 RS-232/422/485 Port, 4 RS-232 Ports
Option C	DC Power, Low Rear I/O, VGA, LVDS, 1 RS-232/422/485 Port, 4 RS-232 Ports
Option D	DC Power, High Rear I/O, DVI, VGA, 1 RS-232/422/485 Port
Option E	DC Power, High Rear I/O, VGA, LVDS, 1 RS-232/422/485 Port, 4 RS-232 Ports

Mainboard Specifications

Processor

- Intel Atom processor N270 (1.6GHz single core with HT)

FSB

- 533MHz

Chipset

- Northbridge: Intel 945GSE chipset
- Southbridge: Intel ICH7M chipset

Memory

- 1 unbuffered non-ECC DDR2 533/667/800 SO-DIMM slot
- Up to 1GB memory capacity

LAN

- Supports Gigabit Ethernet by Intel 82574L Controller

Audio

- HDA Codec by Realtek ALC888 7.1 channel (compliant with Azalia 1.0 specs)
- TPA3005D2 amplifier (for Option C, E)

IDE

- 1 IDE port by Intel ICH7M
- Supports Ultra DMA 66/100 mode
- Supports PIO, Bus Master operation mode

SATA

- 2 SATA ports by Intel ICH7M
- Supports 2 SATA devices
- Supports up to 1.5Gb/s data transfer rate

Graphics

- Onboard graphics integrated in Intel 945GSE

Connectors

► Option A Back Panel

- 1 double stack DB-9 connector
- 1 stack up VGA and DVI-D connector
- 1 stack up RJ45 and USB connector
- 1 double stack USB connector
- 1 Gigabit LAN jack
- 3 audio jacks

► Option B Back Panel

- 1 DB-9 connector
- 1 DVI-I connector
- 2 double stack USB connectors
- 1 Gigabit LAN jack
- 2 audio jacks

► Option C Back Panel

- 1 DB-9 connector
- 1 VGA connector
- 2 double stack USB connectors
- 1 Gigabit LAN jack
- 2 audio jacks

► Option D Back Panel

- 1 DB-9 connector
- 1 stack up VGA and DVI-D connector
- 2 double stack USB connectors
- 1 Gigabit LAN jack
- 2 audio jacks

► Option E Back Panel

- 1 DB-9 connector
- 1 VGA connector
- 1 stack up RJ45 and USB connector
- 1 double stack USB connector
- 1 Gigabit LAN jack
- 2 audio jacks

► Onboard Connectors

- 1 front audio pinheader
- 1 USB 2.0 pinheader (2 ports)
- 1 parallel port connector
- 4 serial port connectors (for option A, B, C, E only)
- 1 SPI Flash ROM pinheader (for debugging)
- 1 chassis intrusion switch pinheader
- 1 S/PDIF-Out pinheader
- 1 amplifier pinheader (for option C, E only)
- 1 LVDS connector (for option C, E only)
- 1 20-pin ATX power connector (for option A only)
- 1 4-pin DC 12V power connector (for option B, C, D, E only)
- 1 4-pin DC 5V/12V power connector (for option B, C, D, E only)

Slots

- 1 Mini PCI-E slot
- 1 32-bit/33MHz PCI slot

Form Factor

- Mini ITX: 170mm x 170mm

Mounting

- 4 mounting holes

Environmental

► Storage Environment

- Temperature: -20°C ~ 80°C
- Humidity: 5% ~ 90% non condensing

► Operation Environment

- Temperature: 0°C ~ 60°C
- Humidity: 5% ~ 90% non condensing

Block Diagram

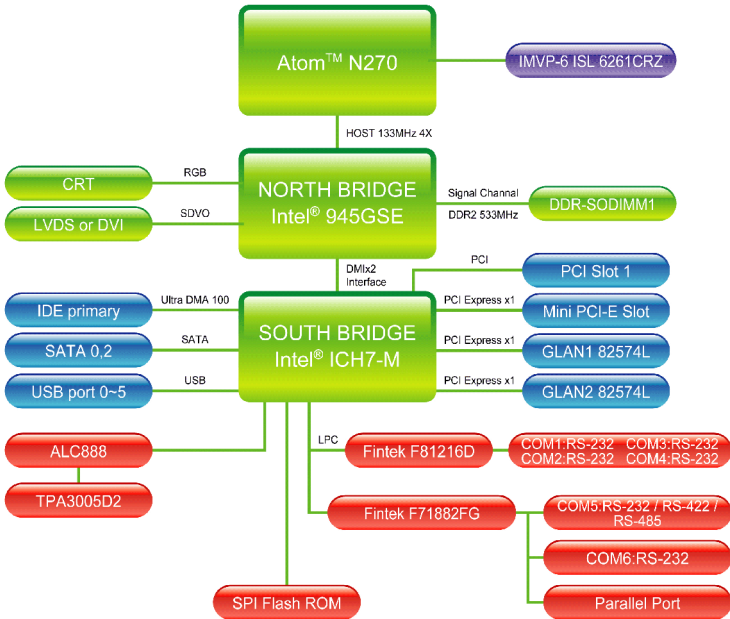

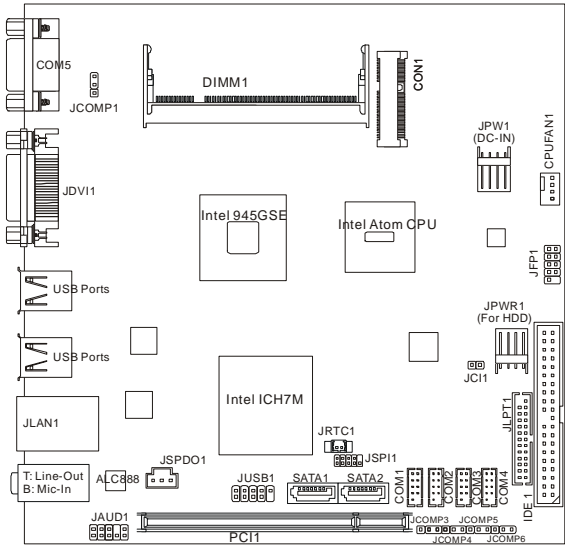

IM-945GSE Series Mini ITX Mainboard - Option B

MS-9830 Mainboard

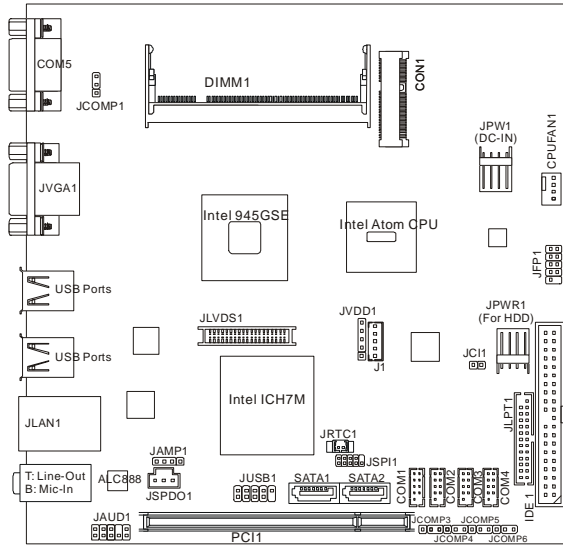

IM-945GSE Series Mini ITX Mainboard - Option C

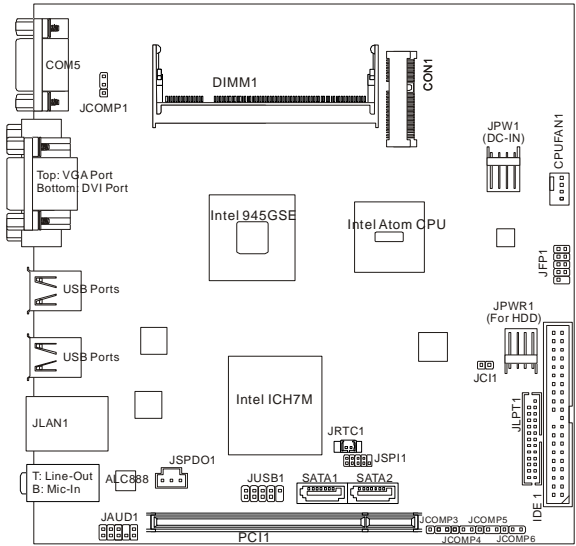

IM-945GSE Series Mini ITX Mainboard - Option D

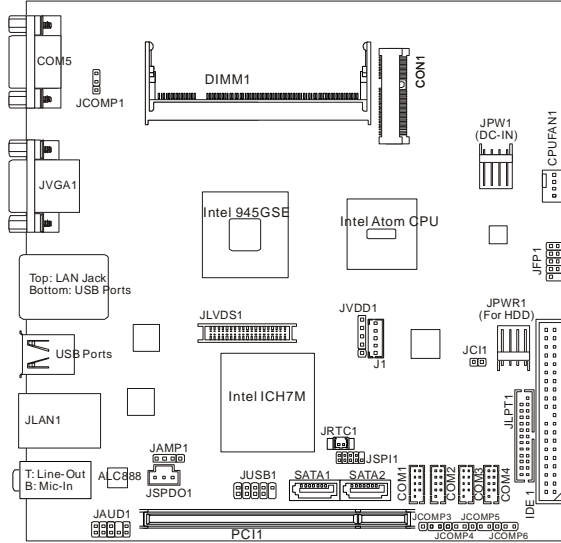

IM-945GSE Series Mini ITX Mainboard - Option E

Board Dimension

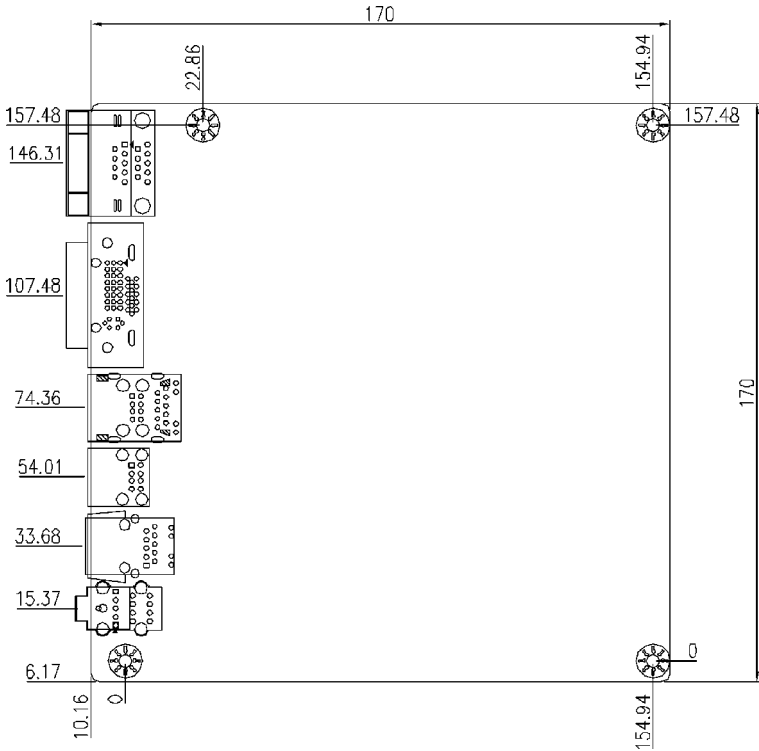

Back Panel & I/O Shield Drawing

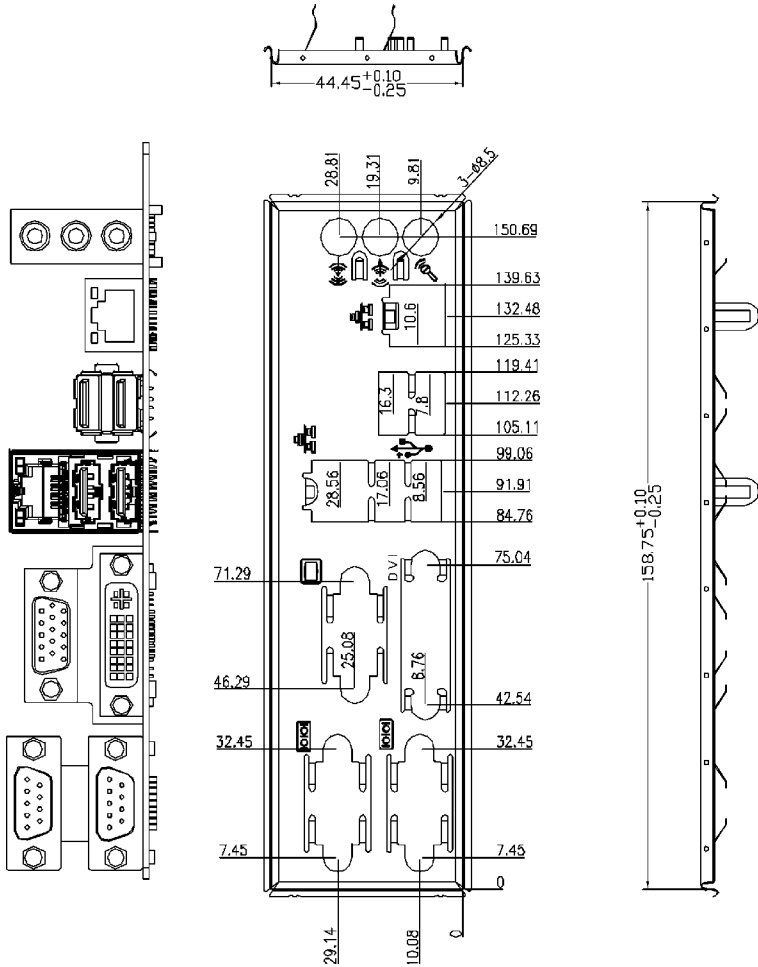

IM-945GSE Series Mini ITX Mainboard - Option A

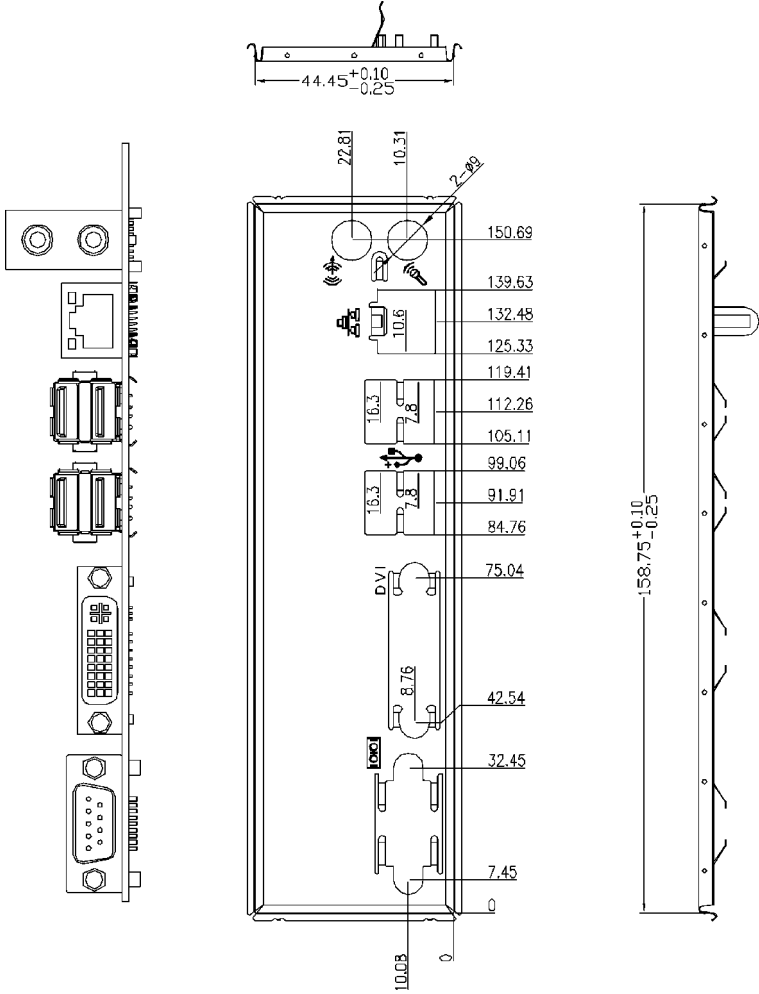

IM-945GSE Series Mini ITX Mainboard - Option B

MS-9830 Mainboard

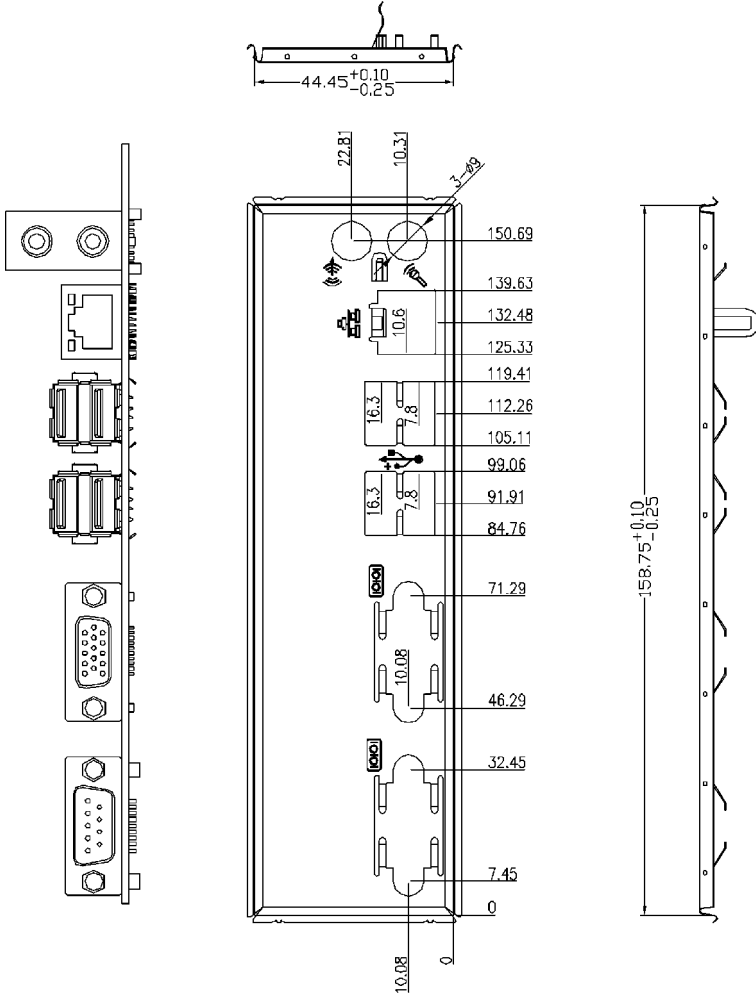

IM-945GSE Series Mini ITX Mainboard - Option C

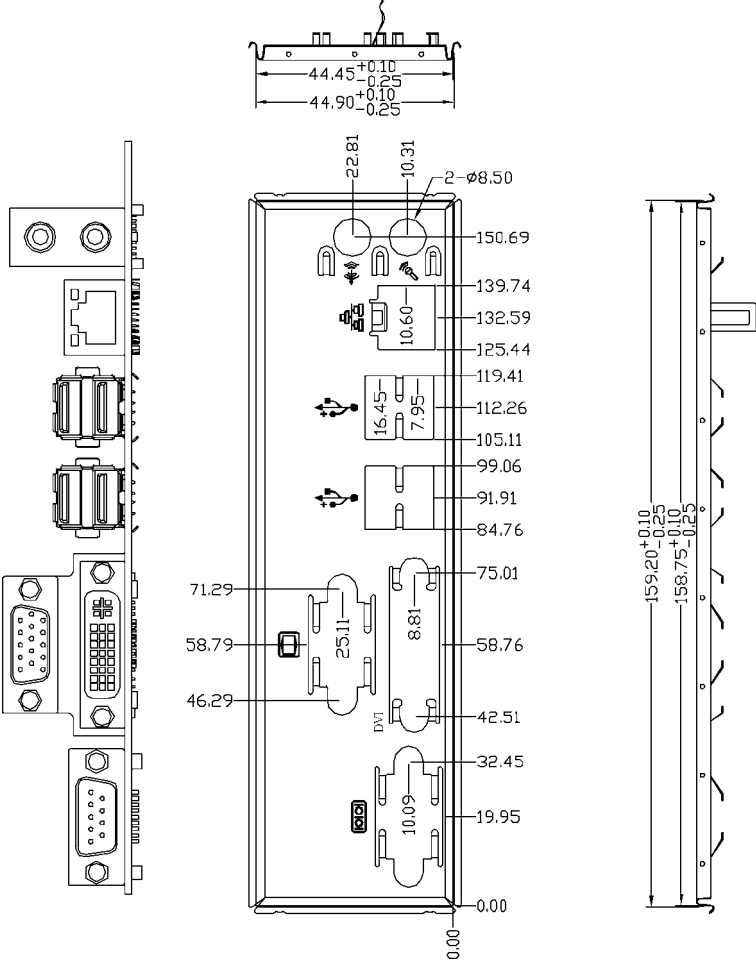

IM-945GSE Series Mini ITX Mainboard - Option D

MS-9830 Mainboard

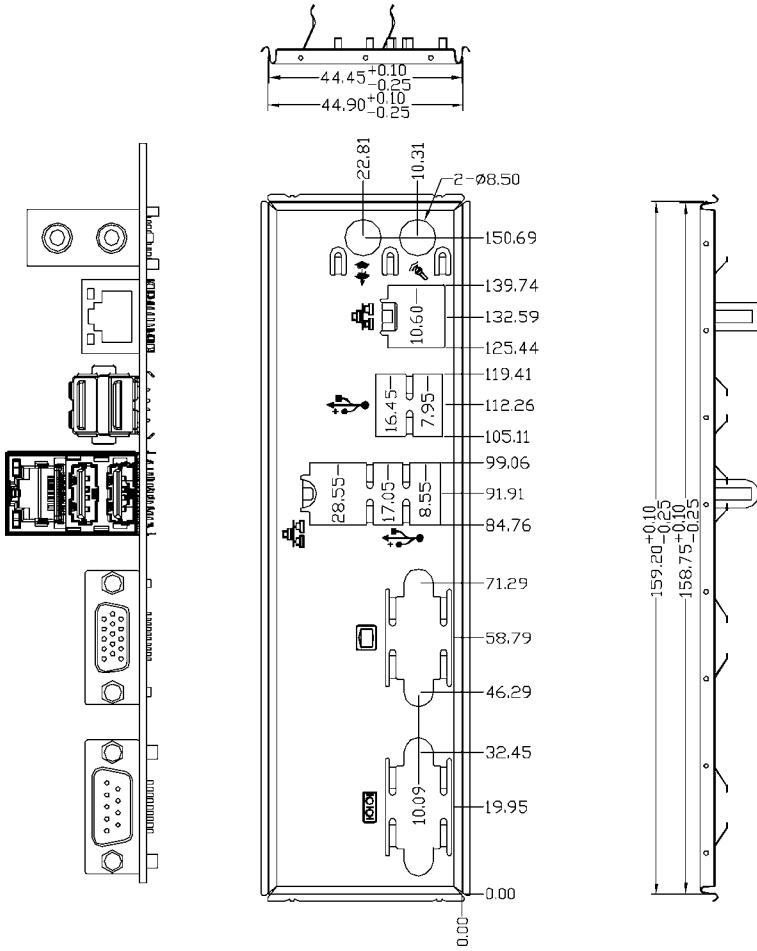

IM-945GSE Series Mini ITX Mainboard - Option E

Power Consumption

Component	Description
CPU	Intel Atom Processor 200 Series
Memory	Corsair 1G DDR2-800 x1
Add-On VGA	NA
Hard Disk	Western 80G IDE 7200rpm HDD x1
Operating System	Microsoft Windows XP Professional SP2

MS-9830-0A (ATX)	3.3V input	5V input	12V input	5VSB	Total Watt
	Current (A)	Current (A)	Current (A)	Current (A)	Watt
Enter DOS (stable)	0.54	1.03	0.30	0.06	10.83W
Enter BIOS (stable)	0.56	1.03	0.30	0.06	10.90W
Idle	0.54	1.10	0.27	0.05	10.77W
CPU Stress 100%	0.54	1.18	0.31	0.05	11.65W
Windows stress (3dMARK2006)	0.55	1.11	0.36	0.05	11.94 W
Windows Desktop Standby S1 without LAN connected (stable)	0.48	1.03	0.25	0.05	9.98W
Windows Desktop Standby S3 without LAN connected (stable)	0	0	0	0.22	1.10W
Windows Desktop Hibernate S4 without LAN connected (stable)	0	0	0	0.13	0.65W
Windows Desktop Soft Off S5 without LAN connected (stable)	0	0	0	0.15	0.75W

MS-9830 Mainboard

Component	Description
CPU	Intel Atom Processor 200 Series
Memory	TRANSCEND 1G DDR2-800 x1
Add-On VGA	NA
Hard Disk	MAXTOR 40G IDE 7200rpm HDD x1
Operating System	Microsoft Windows XP Professional SP2

MS-9830-0A (DC)	12V input	
	Current (A)	Watt
Enter DOS (stable)	0.956A	11.47W
Enter BIOS (stable)	0.952 A	11.42W
Idle	0.934 A	11.21W
CPU Stress 100%	1.02A	12.24W
Windows stress (3dMARK2006)	1.28 A	15.36W
Windows Desktop Standby S1 without LAN connected (stable)	0.875 A	10.50W
Windows Desktop Standby S3 without LAN connected (stable)	0.119 A	1.43W
Windows Desktop Hibernate S4 without LAN connected (stable)	0.05A	0.60W
Windows Desktop Soft Off S5 without LAN connected (stable)	0.05A	0.60W

Safety Compliance & MTBF

Safety Compliance

Certification	Standard number		Title of standard
CE	RFI	EN 55022: 2006	Product family standard
		EN 2006	Limits for harmonic current emission
		EN 1995+A1:2001+A2:2005	Limitation of voltage fluctuation and flicker in low-voltage supply system
	Immunity	EN 55024:1998+A1:2001+A2:2003	Product family standard
BSMI	CNS 13438 乙類(1995年6月版)		
C-Tick	AS/NZS CISPR 22:2006		
FCC	FCC CFR Title 47 Part 15 Subpart B: 2005 Class B		
	CISPR 22: 2006		
VCCI	VCCI V-3:2008 Class B		
	VCCI V-4:2008 Class B		

MTBF - Reliability Prediction

9830	Calculation Model	Operation Temperature (°C)	Operation Environment	Duty Cycle	MTBF (hr.)
option A	Telcordia Issue 1	40	GB, GC - Ground Benign, Controlled	6,429.899614	155,523
option B, D	Telcordia Issue 1	40	GB, GC - Ground Benign, Controlled	6,311.357614	158,445
option C, E	Telcordia Issue 1	40	GB, GC - Ground Benign, Controlled	6,841.490152	146,167

This page is intentionally left blank.

Chapter 2

Hardware Setup

This chapter provides you with the information about hardware setup procedures. While doing the installation, be careful in holding the components and follow the installation procedures. For some components, if you install in the wrong orientation, the components will not work properly.

Use a grounded wrist strap before handling computer components. Static electricity may damage the components.

Quick Components Guide

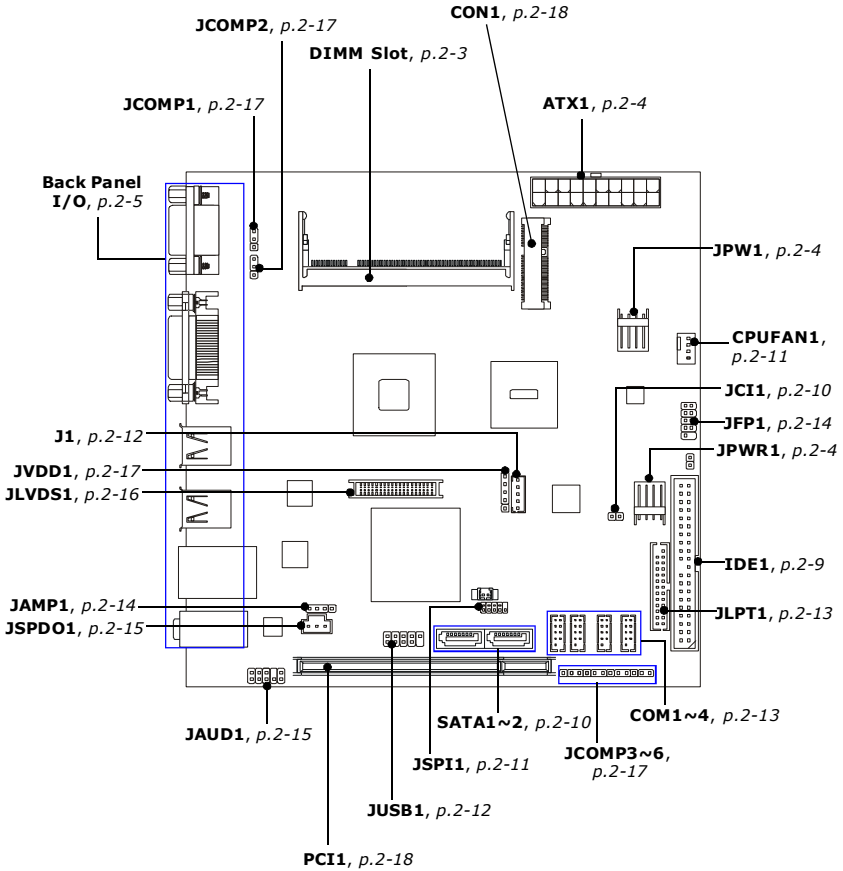

Memory

The DIMM slots are intended for system memory modules.



DDR2 SO-DIMM Slot
200-pin, 1.8V

Installing Memory Modules

1. Locate the SO-DIMM slots on the mainboard.
2. Align the notch on the DIMM with the key on the slot. Insert the DIMM vertically into the SO-DIMM slot. Then push it in until the golden finger on the DIMM is deeply inserted in the SO-DIMM slot.
3. Manually check if the DIMM has been locked in place by the retaining clips at the sides.

Power Supply

System Power Connector: ATX1 (for option A)

This connector allows you to connect a 20-pin power supply. To connect the power supply, make sure the power supply connector is inserted in the proper orientation and the pins are aligned. Then push down the power supply firmly into the connector.

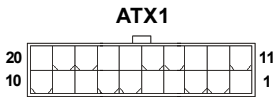

Pin Definition

PIN	SIGNAL	PIN	SIGNAL
1	+3.3V	11	+3.3V
2	+3.3V	12	-12V
3	GND	13	GND
4	+5V	14	PS-ON#
5	GND	15	GND
6	+5V	16	GND
7	GND	17	GND
8	PWROK	18	Res
9	5VSB	19	+5V
10	+12V	20	+5V

12V System Power Connector: JPW1 (for option B, C, D, E)

This 12V power connector is used to provide power to the system & CPU.

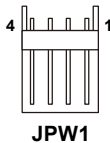

Pin Definition

PIN	SIGNAL
1	12V
2	12V
3	GND
4	GND

5V/12V HDD Power Connector: JPWR1 (for option B, C, D, E)

This connector provides power to the hard disk drives.

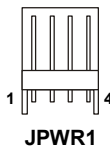

Pin Definition

PIN	SIGNAL
1	5V
2	GND
3	GND
4	12V

Back Panel I/O

Option A

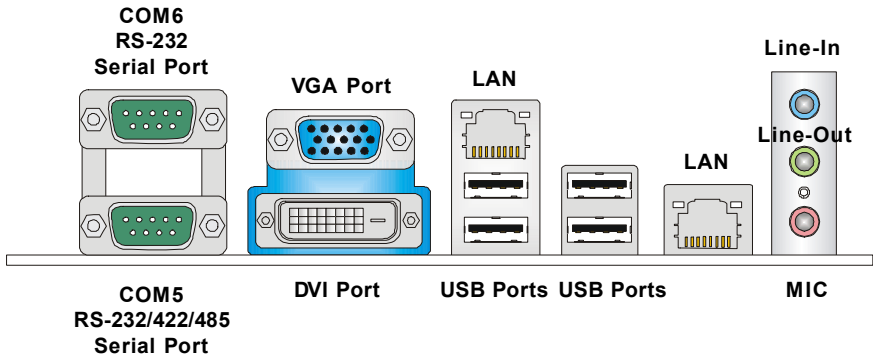

► Serial Port

The serial port is a 16550A high speed communications port that sends/ receives 16 bytes FIFOs. You can attach a serial mouse or other serial devices directly to the connector.

► VGA Port

The DB15-pin female connector is provided for monitor.

► DVI Port

The DVI (Digital Visual Interface) connector allows you to connect a LCD monitor. It provides a high-speed digital interconnection between the computer and its display device. To connect an LCD monitor, simply plug your monitor cable into the DVI connector, and make sure that the other end of the cable is properly connected to your monitor (refer to your monitor manual for more information.)

► USB Port

The USB (Universal Serial Bus) port is for attaching USB devices such as keyboard, mouse, or other USB-compatible devices.

► **LAN**

The standard RJ-45 LAN jack is for connection to the Local Area Network (LAN). You can connect a network cable to it.

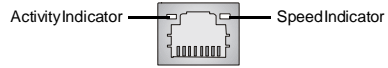

		Left LED	Right LED
		Active LED	100M/1000M Speed LED
LED Color		Yellow	Green/Orange
10M Cable Plug-in	No Transmission	Slow Blinking	OFF
	Transition	SwiftlyBlinking	OFF
100M Cable Plug-in	No Transmission	Slow Blinking	Green(Lighting)
	Transition	SwiftlyBlinking	Green(Lighting)
1000M Cable Plug-in	No Transmission	Slow Blinking	Orange(Lighting)
	Transition	SwiftlyBlinking	Orange(Lighting)
In S3/S4/S5 Standby State		Green (Lighting)	OFF

► **Audio Ports**

These audio connectors are used for audio devices. You can differentiate the color of the audio jacks for different audio sound effects.

- **Line-In (Blue)** - Line In, is used for external CD player, tapeplayer or other audio devices.
- **Line-Out (Green)** - Line Out, is a connector for speakers or headphones.
- **Mic (Pink)** - Mic, is a connector for microphones.

Option B

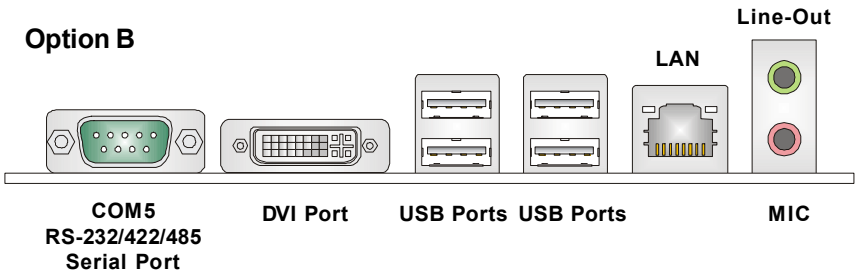

► **Serial Port**

The serial port is a 16550A high speed communications port that sends/ receives 16 bytes FIFOs. You can attach a serial mouse or other serial devices directly to the connector.

► **DVI Port**

The DVI (Digital Visual Interface) connector allows you to connect a LCD monitor. It provides a high-speed digital interconnection between the computer and its display device. To connect an LCD monitor, simply plug your monitor cable into the DVI connector, and make sure that the other end of the cable is properly connected to your monitor (refer to your monitor manual for more information.)

► **USB Port**

The USB (Universal Serial Bus) port is for attaching USB devices such as keyboard, mouse, or other USB-compatible devices.

► **LAN**

The standard RJ-45 LAN jack is for connection to the Local Area Network (LAN). You can connect a network cable to it.

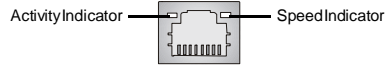

		Left LED	Right LED
		Active LED	100M/1000M Speed LED
LED Color		Yellow	Green/Orange
10M Cable Plug-in	No Transmission	Slow Blinking	OFF
	Transition	Swiftly Blinking	OFF
100M Cable Plug-in	No Transmission	Slow Blinking	Green(Lighting)
	Transition	Swiftly Blinking	Green(Lighting)
1000M Cable Plug-in	No Transmission	Slow Blinking	Orange(Lighting)
	Transition	Swiftly Blinking	Orange(Lighting)
In S3/S4/S5 Standby State		Green (Lighting)	OFF

► **Audio Ports**

These audio connectors are used for audio devices. You can differentiate the color of the audio jacks for different audio sound effects.

- **Line-Out (Green)** - Line Out, is a connector for speakers or headphones.
- **Mic (Pink)** - Mic, is a connector for microphones.

Option C

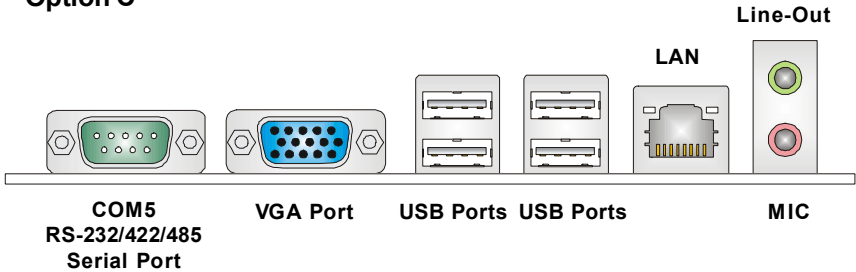

► **Serial Port**

The serial port is a 16550A high speed communications port that sends/ receives 16 bytes FIFOs. You can attach a serial mouse or other serial devices directly to the connector.

► **VGA Port**

The DB15-pin female connector is provided for monitor.

► **USB Port**

The USB (Universal Serial Bus) port is for attaching USB devices such as keyboard, mouse, or other USB-compatible devices.

► **LAN**

The standard RJ-45 LAN jack is for connection to the Local Area Network (LAN). You can connect a network cable to it.

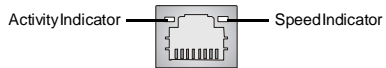

		Left LED	Right LED
		Active LED	100M/1000M Speed LED
LED Color		Yellow	Green/Orange
10M Cable Plug-in	No Transmission	Slow Blinking	OFF
	Transition	SwiftlyBlinking	OFF
100M Cable Plug-in	No Transmission	Slow Blinking	Green(Lighting)
	Transition	SwiftlyBlinking	Green(Lighting)
1000M Cable Plug-in	No Transmission	Slow Blinking	Orange(Lighting)
	Transition	SwiftlyBlinking	Orange(Lighting)
In S3/S4/S5 Standby State		Green (Lighting)	OFF

► **Audio Ports**

These audio connectors are used for audio devices. You can differentiate the color of the audio jacks for different audio sound effects.

- **Line-Out (Green)** - Line Out, is a connector for speakers or headphones.
- **Mic (Pink)** - Mic, is a connector for microphones.

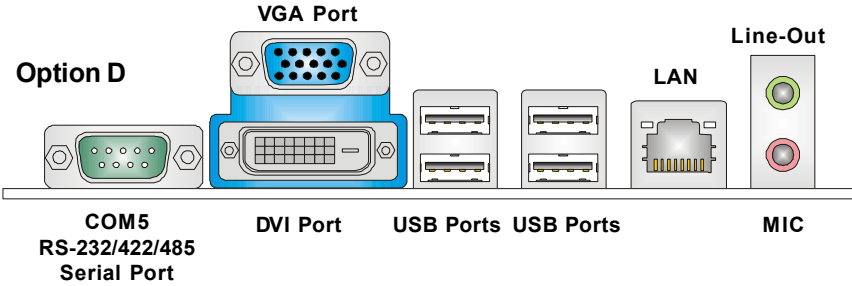

► **Serial Port**

The serial port is a 16550A high speed communications port that sends/ receives 16 bytes FIFOs. You can attach a serial mouse or other serial devices directly to the connector.

► **VGA Port**

The DB15-pin female connector is provided for monitor.

► **DVI Port**

The DVI (Digital Visual Interface) connector allows you to connect a LCD monitor. It provides a high-speed digital interconnection between the computer and its display device. To connect an LCD monitor, simply plug your monitor cable into the DVI connector, and make sure that the other end of the cable is properly connected to your monitor (refer to your monitor manual for more information.)

► **USB Port**

The USB (Universal Serial Bus) port is for attaching USB devices such as keyboard, mouse, or other USB-compatible devices.

► **LAN**

The standard RJ-45 LAN jack is for connection to the Local Area Network (LAN). You can connect a network cable to it.

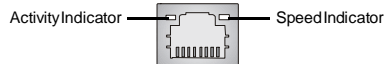

		Left LED	Right LED
		Active LED	100M/1000M Speed LED
LED Color		Yellow	Green/Orange
10M Cable Plug-in	No Transmission	Slow Blinking	OFF
	Transition	SwiftlyBlinking	OFF
100M Cable Plug-in	No Transmission	Slow Blinking	Green(Lighting)
	Transition	SwiftlyBlinking	Green(Lighting)
1000M Cable Plug-in	No Transmission	Slow Blinking	Orange(Lighting)
	Transition	SwiftlyBlinking	Orange(Lighting)
In S3/S4/S5 Standby State		Green (Lighting)	OFF

► **Audio Ports**

These audio connectors are used for audio devices. You can differentiate the color of the audio jacks for different audio sound effects.

- **Line-Out (Green)** - Line Out, is a connector for speakers or headphones.
- **Mic (Pink)** - Mic, is a connector for microphones.

Option E

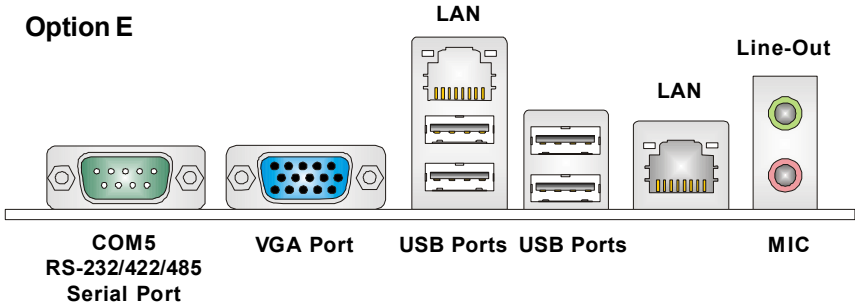

► **Serial Port**

The serial port is a 16550A high speed communications port that sends/ receives 16 bytes FIFOs. You can attach a serial mouse or other serial devices directly to the connector.

► **VGA Port**

The DB15-pin female connector is provided for monitor.

► **USB Port**

The USB (Universal Serial Bus) port is for attaching USB devices such as keyboard, mouse, or other USB-compatible devices.

► **LAN**

The standard RJ-45 LAN jack is for connection to the Local Area Network (LAN). You can connect a network cable to it.

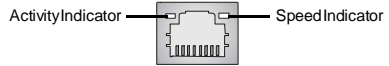

		Left LED	Right LED
		Active LED	100M/1000M Speed LED
LED Color		Yellow	Green/Orange
10M Cable Plug-in	No Transmission	Slow Blinking	OFF
	Transition	Swiftly Blinking	OFF
100M Cable Plug-in	No Transmission	Slow Blinking	Green(Lighting)
	Transition	Swiftly Blinking	Green(Lighting)
1000M Cable Plug-in	No Transmission	Slow Blinking	Orange(Lighting)
	Transition	Swiftly Blinking	Orange(Lighting)
In S3/S4/S5 Standby State		Green (Lighting)	OFF

► **Audio Ports**

These audio connectors are used for audio devices. You can differentiate the color of the audio jacks for different audio sound effects.

- **Line-Out (Green)** - Line Out, is a connector for speakers or headphones.
- **Mic (Pink)** - Mic, is a connector for microphones.

Connector

IDE Connector: IDE1

This connector supports IDE hard disk drives, optical disk drives and other IDE devices.

IDE1

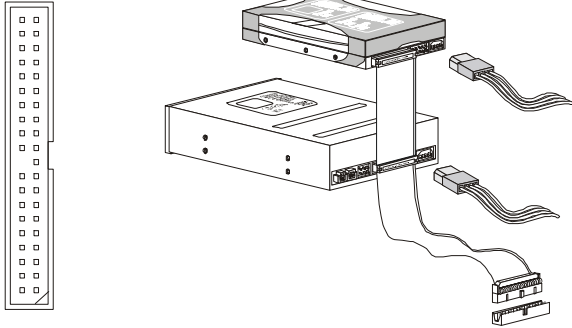

Important

If you install two IDE devices on the same cable, you must configure the drives separately to master / slave mode by setting jumpers. Refer to IDE device's documentation supplied by the vendors for jumper setting instructions.

Chassis Intrusion Connector: JCI1

This connector connects to the chassis intrusion switch cable. If the chassis is opened, the chassis intrusion mechanism will be activated. The system will record this status and show a warning message on the screen. To clear the warning, you must enter the BIOS utility and clear the record.

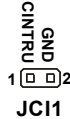

Serial ATA Connector: SATA1, SATA2

This connector is a high-speed Serial ATA interface port. Each connector can connect to one Serial ATA device.

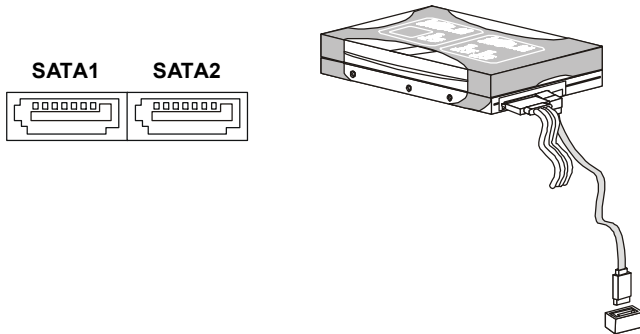

Important

Please do not fold the Serial ATA cable into 90-degree angle. Otherwise, data loss may occur during transmission.

SPI Flash ROM Pinheader: JSPI1

This pinheader is used to flash SPI flash ROM.



Pin Definition

Pin	Description	Pin	Description
1	VCC3_SB	2	VCC3_SB
3	SPI_MISO_F	4	SPI_MOSI_F
5	SPI_CS0_F#	6	SPI_CLK_F
7	GND	8	GND
9	SPI_HOLD#	10	NC

Fan Power Connector: CPUFAN1

The fan power connector supports system cooling fan with +12V. When connecting the wire to the connectors, always note that the red wire is the positive and should be connected to the +12V; the black wire is Ground and should be connected to GND. If the mainboard has a System Hardware Monitor chipset onboard, you must use a specially designed fan with speed sensor to take advantage of the CPU fan control.

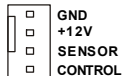

CPUFAN1



Important

Please refer to the recommended CPU fans at CPU vendor's official website or consult the mainboard vendor for proper CPU cooling fan.

Backlight Connector: J1 (for option C, E)

This connector is provided for LCD backlight options.

**Pin Definition**

PIN	SIGNAL
1	12V
2	GND
3	Inverter On
4	Backlight Control
5	5V

Front USB Pinheader: JUSB1

This pinheader, compliant with Intel® I/O Connectivity Design Guide, is ideal for connecting high-speed USB interface peripherals such as **USB HDD, digital cameras, MP3 players, printers, modems and the like.**

**Pin Definition**

PIN	SIGNAL	PIN	SIGNAL
1	VCC	2	VCC
3	USB0-	4	USB1-
5	USB0+	6	USB1+
7	GND	8	GND
9	Key (no pin)	10	USBOC

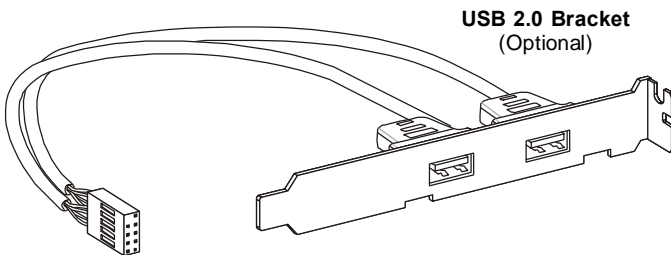
**Important**

Note that the pins of VCC and GND must be connected correctly to avoid possible damage.

Serial Port Connector: COM1 ~ COM4 (for option A, B, C, E)

This connector is a 16550A high speed communications port that sends/receives 16 bytes FIFOs. You can attach a serial device to it through the optional serial port bracket.

COM1~4



Pin Definition

PIN	SIGNAL	DESCRIPTION
1	DCD	Data Carry Detect
2	SIN	Serial In or Receive Data
3	SOUT	Serial Out or Transmit Data
4	DTR	Data Terminal Ready
5	GND	Ground
6	DSR	Data Set Ready
7	RTS	Request To Send
8	CTS	Clear To Send
9	VCC_COM	Power Source

Parallel Port Header: JLPT1

The mainboard provides a 26-pin header for connection to an optional parallel port bracket. The parallel port is a standard printer port that supports Enhanced Parallel Port (EPP) and Extended Capabilities Parallel Port (ECP) mode.

JLPT1

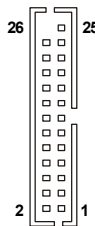

PIN	SIGNAL	PIN	SIGNAL	PIN	SIGNAL	PIN	SIGNAL
1	RSTB#	2	AFD#	15	PRND6	16	GND
3	PRND0	4	ERR#	17	PRND7	18	GND
5	PRND1	6	PINIT#	19	ACK#	20	GND
7	PRND2	8	LPT_SLIN#	21	BUSY	22	GND
9	PRND3	10	GND	23	PE	24	GND
11	PRND4	12	GND	25	SLCT	26	KEY
13	PRND5	14	GND				

Audio Amplifier Connector: JAMP1 (for option C, E)

The JAMP1 is used to connect audio amplifiers to enhance audio performance.



Pin Definition

PIN	SIGNAL
1	AMP_L-
2	AMP_L+
3	AMP_R-
4	AMP_R+

Front Panel Connector: JFP1

The mainboard provides one front panel connector for electrical connection to the front panel switches and LEDs. The JFP1 is compliant with Intel® Front Panel I/O Connectivity Design Guide.

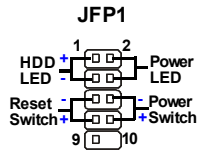

Pin Definition

PIN	SIGNAL	DESCRIPTION
1	HD_LED +	Hard disk LED pull-up
2	FPPWR/SLP	MSG LED pull-up
3	HD_LED -	Hard disk active LED
4	FPPWR/SLP	MSG LED pull-up
5	RST_SW -	Reset Switch low reference pull-down to GND
6	PWR_SW -	Power Switch low reference pull-down to GND
7	RST_SW +	Reset Switch high reference pull-up
8	PWR_SW+	Power Switch high reference pull-up
9	RSVD_DNU	Reserved. Do not use.

S/PDIF-Out Connector: JSPDO1

This connector is used to connect S/PDIF (Sony & Philips Digital Interconnect Format) interface for digital audio transmission.

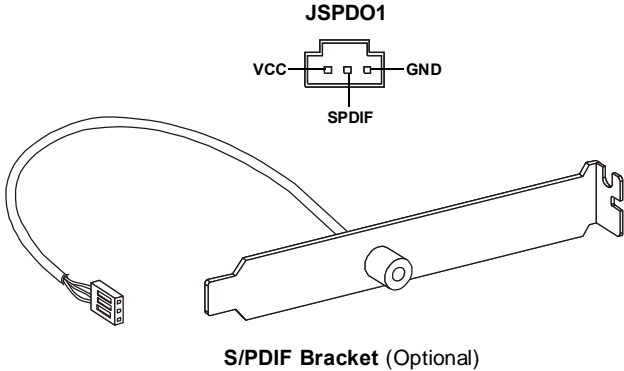

Front Panel Audio Connector: JAUD1

This connector allows you to connect the front panel audio and is compliant with Intel® Front Panel I/O Connectivity Design Guide.



HD Audio Pin Definition

PIN	SIGNAL	DESCRIPTION
1	MIC_L	Microphone - Left channel
2	GND	Ground
3	MIC_R	Microphone - Right channel
4	PRESENCE#	Active low signal-signals BIOS that a High Definition Audio dongle is connected to the analog header. PRESENCE# = 0 when a High Definition Audio dongle is connected
5	LINE out_R	Analog Port - Right channel
6	MIC_JD	Jack detection return from front panel microphone JACK1
7	Front_JD	Jack detection sense line from the High Definition Audio CODEC jack detection resistor network
8	NC	No control
9	LINE out_L	Analog Port - Left channel
10	LINEout_JD	Jack detection return from front panel JACK2

LVDS Flat Panel Connector: JLVD51 (for option C, E)

The LVDS (Low Voltage Differential Signal) connector provides a digital interface typically used with flat panels. After connecting an LVDS interfaced flat panel to the JLVD51, be sure to check the panel datasheet and set the **JVDD1 LVDS Power Selection Jumper** (p. 2-17) to a proper voltage.

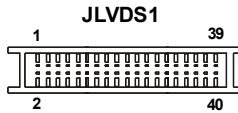

SIGNAL	PIN		SIGNAL
+12V	2	1	+12V
+12V	4	3	+12V
GND	6	5	+12V
GND	8	7	VCC3/VCC5
LCD_VDD	10	9	LCD_VDD
LDDC_DATA	12	11	LDDC_CLK
LVDS_VDDEN	14	13	L_BKLTCTL
GND	16	15	L_BKLTEN
LA_DATA0	18	17	LA_DATA0#
LA_DATA1	20	19	LA_DATA1#
LA_DATA2	22	21	LA_DATA2#
LA_CLK	24	23	LA_CLK#
LA_DATA3	26	25	LA_DATA3#
GND	28	27	GND
LB_DATA0	30	29	LB_DATA0#
LB_DATA1	32	31	LB_DATA1#
LB_DATA2	34	33	LB_DATA2#
LB_CLK	36	35	LB_CLK#
LB_DATA3	38	37	LB_DATA3#
GND	40	39	GND

Jumper

LVDS Power Selection Jumper: JVDD1 (for option C, E)

Use this jumper to specify the operation voltage of the LVDS interfaced flat panel.

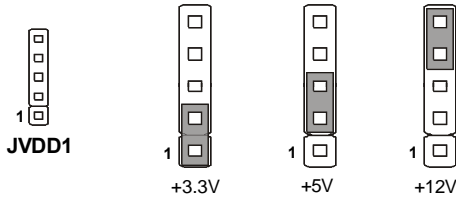

COM Port Power Jumper: JCOMP2 (for option A), JCOMP1, JCOMP3~6 (for option A, B, C, E)

These jumpers specify the operation voltage of the onboard serial ports.

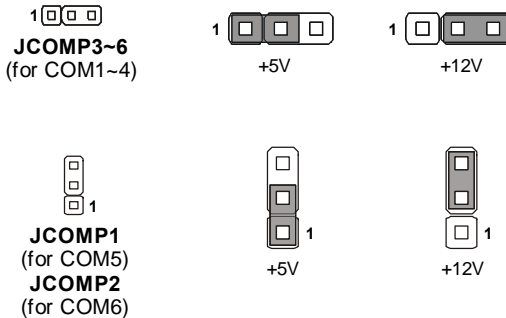

Slot

PCI (Peripheral Component Interconnect) Express Slot

The CON1 is Mini PCI-E connector for wireless LAN, TV tuner, and Robson NAND Flash.



Mini PCI-E Slot

PCI (Peripheral Component Interconnect) Slot

The PCI slot supports LAN card, SCSI card, USB card, and other add-on cards that comply with PCI specifications.



32-bit PCI Slot



Important

When adding or removing expansion cards, make sure that you unplug the power supply first. Meanwhile, read the documentation for the expansion card to configure any necessary hardware or software settings for the expansion card, such as jumpers, switches or BIOS configuration.

Chapter 3

BIOS Setup

This chapter provides information on the BIOS Setup program and allows you to configure the system for optimum use.

You may need to run the Setup program when:

- ◆ An error message appears on the screen during the system booting up, and requests you to run SETUP.
- ◆ You want to change the default settings for customized features.

Entering Setup

Power on the computer and the system will start POST (Power On Self Test) process. When the message below appears on the screen, press key to enter Setup.

Press Del to enter SETUP

If the message disappears before you respond and you still wish to enter Setup, restart the system by turning it OFF and On or pressing the RESET button. You may also restart the system by simultaneously pressing <Ctrl>, <Alt>, and <Delete> keys.



Important

1. The items under each BIOS category described in this chapter are under continuous update for better system performance. Therefore, the description may be slightly different from the latest BIOS and should be held for reference only.
2. Upon boot-up, the 1st line appearing after the memory count is the BIOS version. It is usually in the format:

A9830IMS V1.0 102708 where:

1st digit refers to BIOS maker as A = AMI, W = AWARD, and P = PHOENIX.

2nd - 5th digit refers to the model number.

6th digit refers to the chipset as I = Intel, N = nVidia, A = ATi, K=AMD and V = VIA.

7th - 8th digit refers to the customer as MS = all standard customers.

V1.0 refers to the BIOS version.

102708 refers to the date this BIOS was released.

Control Keys

<↑>	Move to the previous item
<↓>	Move to the next item
<←>	Move to the item in the left hand
<→>	Move to the item in the right hand
<Enter>	Select the item
<Esc>	Jumps to the Exit menu or returns to the main menu from a submenu
<+/PU>	Increase the numeric value or make changes
<-/PD>	Decrease the numeric value or make changes
<F6>	Load Optimized Defaults
<F7>	Load Fail-Safe Defaults
<F10>	Save all the CMOS changes and exit

Getting Help

After entering the Setup menu, the first menu you will see is the Main Menu.

Main Menu

The main menu lists the setup functions you can make changes to. You can use the arrow keys (↑↓) to select the item. The on-line description of the highlighted setup function is displayed at the bottom of the screen.

Sub-Menu

If you find a right pointer symbol (as shown in the right view) appears to the left of certain fields that means a sub-menu can be launched from this field. A sub-menu contains additional options for a field parameter. You can use arrow keys (↑↓) to highlight the field and press <Enter> to call up the sub-menu. Then you can use the control keys to enter values and move from field to field within a sub-menu. If you want to return to the main menu, just press the <Esc >.

▶ Primary IDE Master
▶ Primary IDE Slave

General Help <F1>

The BIOS setup program provides a General Help screen. You can call up this screen from any menu by simply pressing <F1>. The Help screen lists the appropriate keys to use and the possible selections for the highlighted item. Press <Esc> to exit the Help screen.

The Menu Bar

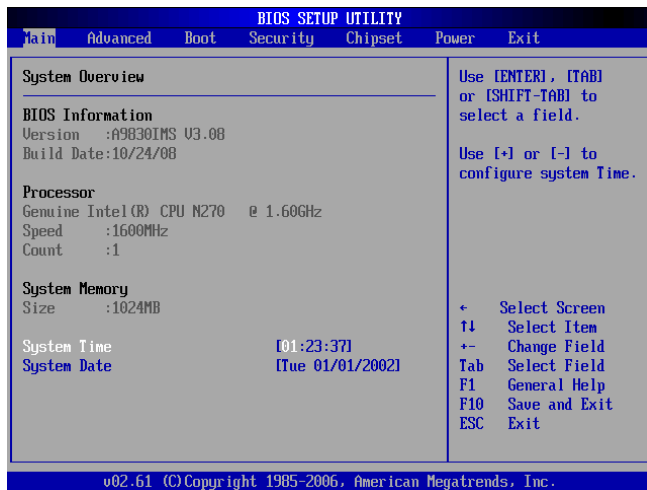

► Main

Use this menu for basic system configurations, such as time, date etc.

► Advanced

Use this menu to set up the items of special enhanced features.

► Boot

Use this menu to specify the priority of boot devices.

► Security

Use this menu to set supervisor and user passwords.

► Chipset

This menu controls the advanced features of the onboard Northbridge and Southbridge.

► Power

Use this menu to specify your settings for power management.

► Exit

This menu allows you to load the BIOS default values or factory default settings into the BIOS and exit the BIOS setup utility with or without changes.

Main

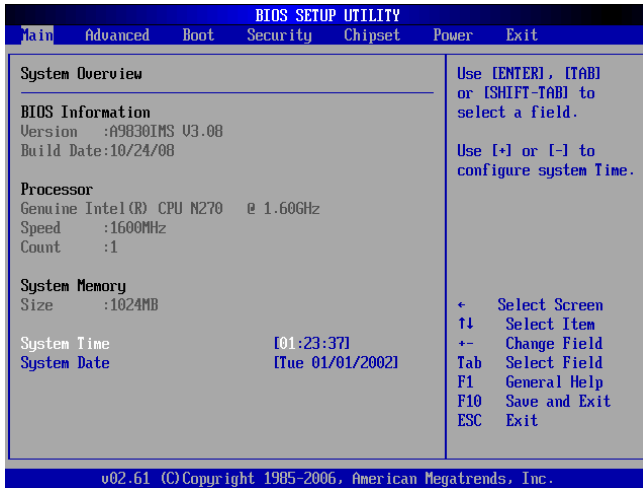

► BIOS Information, Processor, System Memory

These items show the firmware and hardware specifications of your system. Read only.

► System Time

The time format is <Hour> <Minute> <Second>.

► System Date

The date format is <Day>, <Month> <Date> <Year>.

Advanced

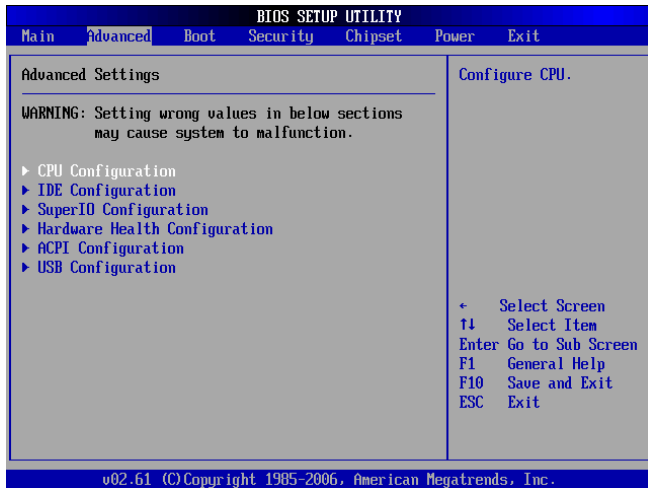

► CPU Configuration

These items show the advanced specifications of your CPU. Read only.



► **Max CPUID Value Limit**

The Max CPUID Value Limit BIOS feature allows you to circumvent problems with older operating systems that do not support the Intel Pentium 4 processor with Hyper-Threading Technology. When enabled, the processor will limit the maximum CPUID input value to 03h when queried, even if the processor supports a higher CPUID input value. When disabled, the processor will return the actual maximum CPUID input value of the processor when queried.

► **Execute Disable Bit Capability**

Intel's Execute Disable Bit functionality can prevent certain classes of malicious "buffer overflow" attacks when combined with a supporting operating system. This functionality allows the processor to classify areas in memory by where application code can execute and where it cannot. When a malicious worm attempts to insert code in the buffer, the processor disables code execution, preventing damage or worm propagation.

► **Hyper Threading Technology**

The processor uses Hyper Threading technology to increase transaction rates and reduces end-user response times. The technology treats the two cores inside the processor as two logical processors that can execute instructions simultaneously. In this way, the system performance is highly improved. If you disable the function, the processor will use only one core to execute the instructions. ***Please disable this item if your operating system doesn't support HT Function, or unreliability and instability may occur.***

► **Intel(R) SpeedStep(tm) Tech**

EIST (Enhanced Intel SpeedStep Technology) allows the system to dynamically adjust processor voltage and core frequency, which can result in decreased average power consumption and decreased average heat production.

► IDE Configuration

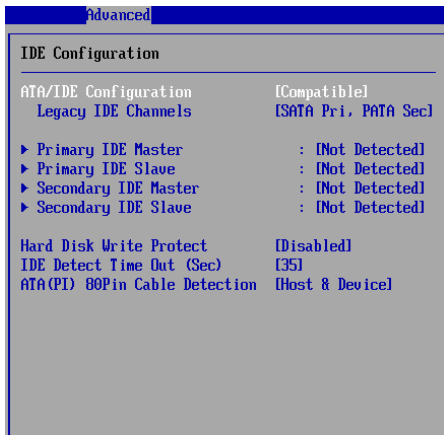

► ATA/IDE Configuration

This setting specifies the operation mode of the onboard ATA/IDE controller.

► Legacy IDE Channels

This setting specifies the IDE channels.

► Primary/Secondary IDE Master/Slave

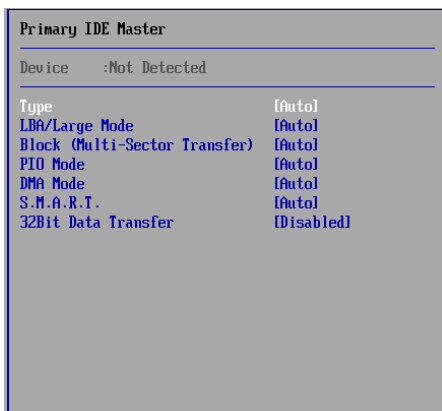

[Type]	Press PgUp/<+> or PgDn/<-> to select [Manual], [None] or [Auto] type. Note that the specifications of your drive must match with the drive table. The hard disk will not work properly if you enter improper information for this category. If your hard disk drive type is not matched or listed, you can use [Manual] to define your own drive type manually.
[LBA/Large Mode]	Enabling LBA causes Logical Block Addressing to be used in place of Cylinders, Heads and Sectors
[Block(Multi-Sector Transfer)]	Any selection except Disabled determines the number of sectors transferred per block
[PIO Mode]	Indicates the type of PIO (Programmed Input/Output)
[DMA Mode]	Indicates the type of Ultra DMA
[S.M.A.R.T.]	This allows you to activate the S.M.A.R.T. (Self-Monitoring Analysis & Reporting Technology) capability for the hard disks. S.M.A.R.T is a utility that monitors your disk status to predict hard disk failure. This gives you an opportunity to move data from a hard disk that is going to fail to a safe place before the hard disk becomes offline.
[32 Bit Data Transfer]	Enables 32-bit communication between CPU and IDE device

► Hard Disk Write Protect

This option allows users to write protect boot sector on hard disk to protect against viruses.

► IDE Detect Time Out (Sec)

This setting allows you to set the time out value for the BIOS to delay the initialization of IDE devices.

► ATA(PI) 80Pin Cable Detection

This BIOS feature allows you to control whether both IDE controller and IDE device should be allowed to detect the type of IDE cable used.

► Super IO Configuration

Option A

Advanced	
Configure F71882F Super IO Chipset	
Serial Port5 Address	[3F8/IRQ4]
Serial Port5 Mode	[RS232]
Serial Port6 Address	[Disabled]
Parallel Port Address	[Disabled]
Watch Dog	[Disabled]
Serial Port1 Address	[3E8]
Serial Port1 IRQ	[11]
Serial Port2 Address	[2E8]
Serial Port2 IRQ	[10]
Serial Port3 Address	[2F0]
Serial Port3 IRQ	[11]
Serial Port4 Address	[2E0]
Serial Port4 IRQ	[10]

Option B

Advanced	
Configure F71882F Super IO Chipset	
Serial Port5 Address	[3F8/IRQ4]
Serial Port5 Mode	[RS232]
Parallel Port Address	[Disabled]
Watch Dog	[Disabled]
Serial Port1 Address	[3F8]
Serial Port1 IRQ	[4]
Serial Port2 Address	[2E8]
Serial Port2 IRQ	[9]
Serial Port3 Address	[Disabled]
Serial Port4 Address	[2E0]
Serial Port4 IRQ	[10]

Option C, E

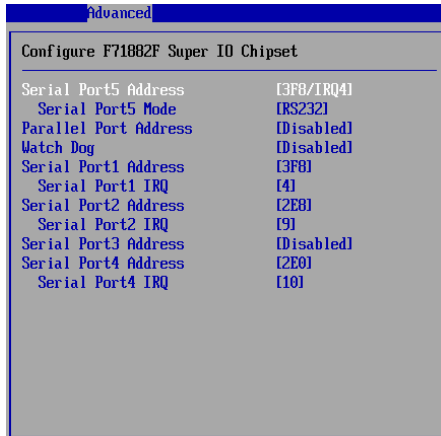

Option D



► **Serial Port 1/2/3/4/5/6 Address, Serial Port 1/2/3/4 IRQ**

Select an address and a corresponding interrupt for the serial port.

► **Serial Port5 Mode**

This setting specifies the serial port5 mode.

► **Parallel Port Address**

Select an address for the parallel port.

► **Watch Dog**

You can enable the system watch-dog timer, a hardware timer that generates either an NMI or a reset when the software that it monitors does not respond as expected each time the watch dog polls it.

► **Hardware Health Configuration**

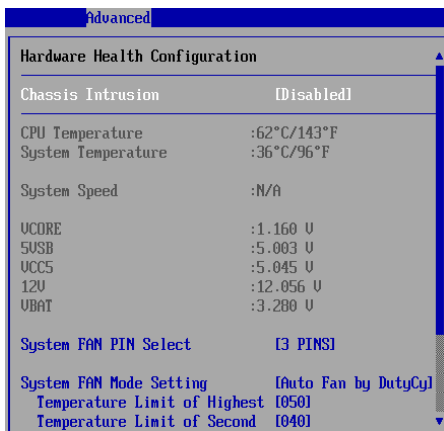

► **Chassis Intrusion**

The field enables or disables the feature of recording the chassis intrusion status and issuing a warning message if the chassis is once opened. To clear the warning message, set the field to [Reset]. The setting of the field will automatically return to [Enabled] later.

► **CPU Temperature, System Temperature, System Speed, VCORE, 5VSB, VCC5, 12V, VBAT**

These items display the current status of all of the monitored hardware devices/components such as CPU voltage, temperatures and all fans' speeds.

► **System Fan Pin Select**

This setting specifies the pin numbers of the system fan power connector.

► **System Fan Mode Setting**

This setting controls the Smart Fan feature. Smart Fan is an excellent feature which will adjust the CPU/system fan speed automatically depending on the current CPU temperature to prevent your CPU from overheating.

► **Temperature Limit of Highest, Temperature Limit of Second**

You can select a temperature tolerance value here for the specific range of the Smart Fan function.

► **ACPI Settings**

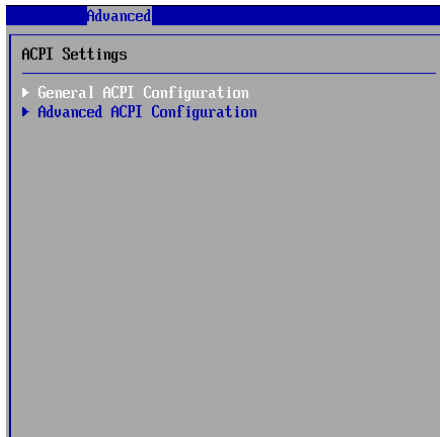

► **General ACPI Configuration**

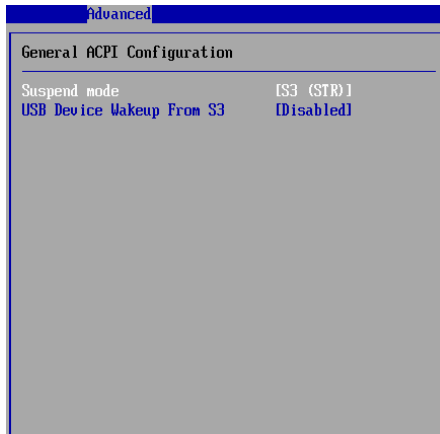

► **Suspend Mode**

This item specifies the power saving modes for ACPI function. If your oper-

ating system supports ACPI, such as Windows 98SE, Windows ME and Windows 2000, you can choose to enter the Standby mode in S1 (POS) or S3 (STR) fashion through the setting of this field.

► USB Device Wakeup From S3

The item allows the activity of the USB device to wake up the system from S3 (Suspend to RAM) sleep state.

► Advanced ACPI Configuration

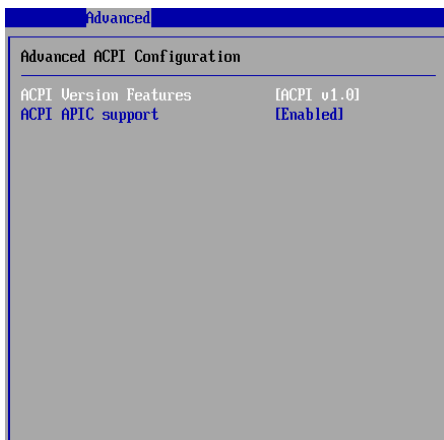

► ACPI Version Features

This setting allows you to select the ACPI version.

► ACPI APIC Support

This BIOS feature is used to enable or disable the motherboard's APIC (Advanced Programmable Interrupt Controller). The APIC provides multiprocessor support, more IRQs and faster interrupt handling.

► USB Configuration**► Legacy USB Support**

Set to [Enabled] if your need to use any USB device in the operating system that does not support or have any USB driver installed, such as DOS and SCO Unix. Set to [Disabled] only if you want to use any USB device other than the USB mouse.

► BIOS EHCI Hand-Off

This setting allows you to enable or disable a workaround for operating systems without EHCI (Enhanced Host Controller Interface) hand-off support. The Enhanced Host Controller Interface (EHCI) specification describes the register-level interface for a Host Controller for the Universal Serial Bus (USB) Revision 2.0.

► **USB Mass Storage Device Configuration**



► **USB Mass Storage Reset Delay**

This setting controls the number of seconds the POST waits for the USB mass storage device after the start unit command is sent.

► **Emulation Type**

This setting enables you to set the type of device you want the USB mass storage device to emulate.

Boot

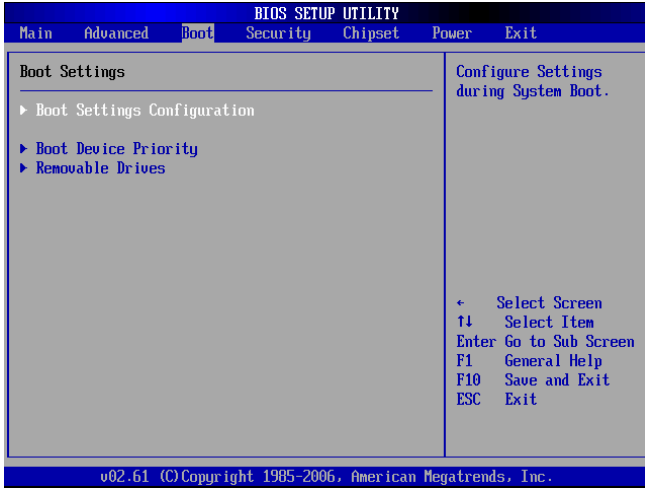

▶ Boot Settings Configuration

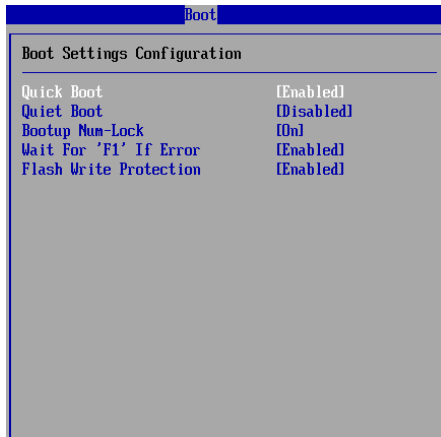

► Quick Boot

Enabling this setting will cause the BIOS power-on self test routine to skip some of its tests during bootup for faster system boot.

► Quiet Boot

This BIOS feature determines if the BIOS should hide the normal POST messages with the motherboard or system manufacturer's full-screen logo.

When it is enabled, the BIOS will display the full-screen logo during the boot-up sequence, hiding normal POST messages.

When it is disabled, the BIOS will display the normal POST messages, instead of the full-screen logo.

Please note that enabling this BIOS feature often adds 2-3 seconds of delay to the booting sequence. This delay ensures that the logo is displayed for a sufficient amount of time. Therefore, it is recommended that you disable this BIOS feature for a faster boot-up time.

► Bootup Num-Lock

This setting is to set the Num Lock status when the system is powered on. Setting to [On] will turn on the Num Lock key when the system is powered on. Setting to [Off] will allow users to use the arrow keys on the numeric keypad.

► Wait For 'F1' If Error

When this setting is set to [Enabled] and the boot sequence encounters an error, it asks you to press F1. If disabled, the system continues to boot without waiting for you to press any keys.

► Flash Write Protection

This function protects the BIOS from accidental corruption by unauthorized users or computer viruses.

► Boot Device Priority, Removable Drives

The items allow you to set the sequence of boot devices/removable drives. First press <Enter> to enter the sub-menu. Then you may use the arrow keys (↑↓) to select the desired device, then press <+>, <-> or <PageUp>, <PageDown> key to move it up/down in the priority list.

Security

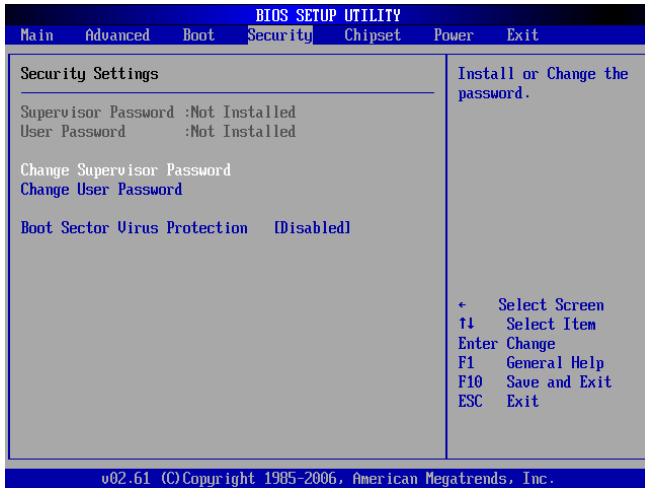

► Supervisor Password / Change Supervisor Password

Supervisor Password controls access to the BIOS Setup utility. These settings allow you to set or change the supervisor password.

► User Password / Change User Password

User Password controls access to the system at boot. These settings allow you to set or change the user password.

► Boot Sector Virus Protection

This function protects the BIOS from accidental corruption by unauthorized users or computer viruses. When enabled, the BIOS' data cannot be changed when attempting to update the BIOS with a Flash utility. To successfully update the BIOS, you'll need to disable this Flash BIOS Protection function.

You should enable this function at all times. The only time when you need to disable it is when you want to update the BIOS. After updating the BIOS, you should immediately re-enable it to protect it against viruses.

Chipset

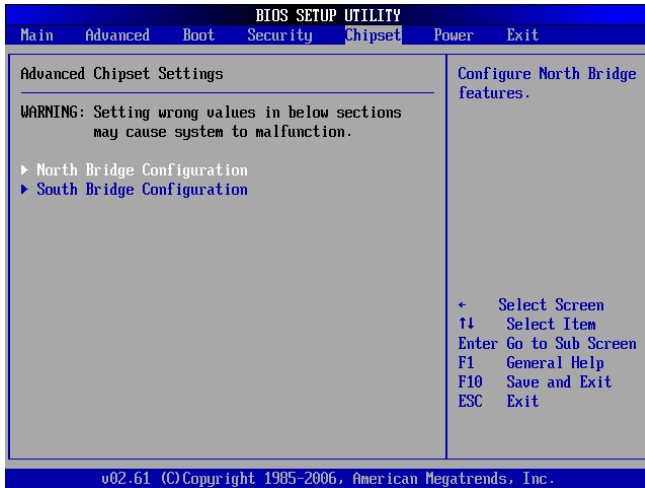

▶ North Bridge Configuration

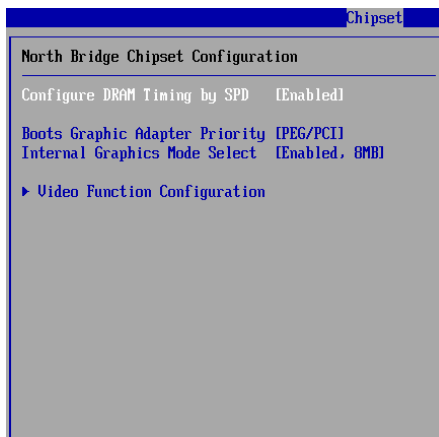

▶ **Configure DRAM Timing by SPD**

Selects whether DRAM timing is controlled by the SPD (Serial Presence Detect) EEPROM on the DRAM module. Setting to [Auto By SPD] enables DRAM timings and the following related items to be determined by BIOS based on the configurations on the SPD. Selecting [Manual] allows users to configure the DRAM timings and the following related items manually.

▶ **Boot Graphics Adapter Priority**

This item specifies which VGA card is your primary graphics adapter.

▶ **Internal Graphics Mode Select**

The field specifies the size of system memory allocated for video memory.

► Video Function Configuration

Option A, D

Video Function Configuration	
DUMT Mode Select	[DUMT Mode]
Boot Display Device	[CRT]

Option B

Video Function Configuration	
DUMT Mode Select	[DUMT Mode]

Option C, E

Video Function Configuration	
DVMT Mode Select	[DVMT Mode]
Boot Display Device	[CRT]
Flat Panel Type	[1024 * 768 18bit]

► DVMT Mode Select

Intel's Dynamic Video Memory Technology (DVMT) allows the system to dynamically allocate memory resources according to the demands of the system at any point in time. The key idea in DVMT is to improve the efficiency of the memory allocated to either system or graphics processor.

It is recommended that you set this BIOS feature to DVMT Mode for maximum performance. Setting it to DVMT Mode ensures that system memory is dynamically allocated for optimal balance between graphics and system performance.

► Boot Display Device

Use the field to select the type of device you want to use as the display(s) of the system.

► Flat Panel Type

Use the field to select the resolution of the flat panel display.

► South Bridge Configuration

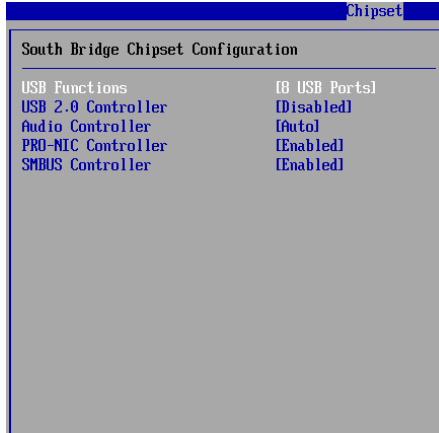

► **USB Functions**

This setting specifies the function of the onboard USB controller.

► **USB 2.0 Controller, Audio Controller, PRO-NIC Controller, SMBUS Controller**

These settings enable/disable the specified onboard controllers.

Power

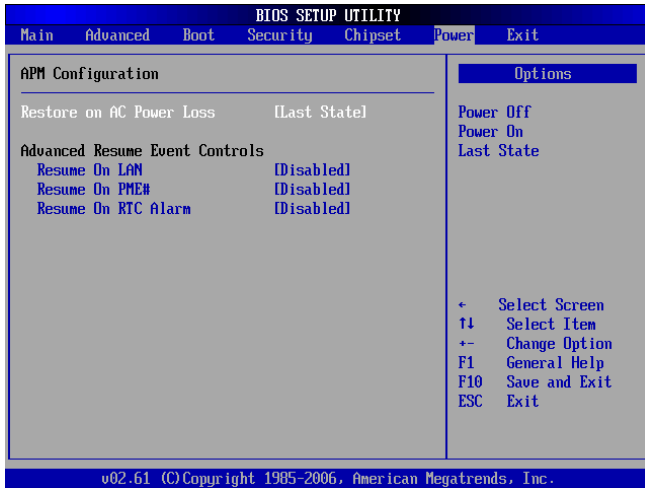

► Restore on AC Power Loss

This setting specifies whether your system will reboot after a power failure or interrupt occurs. Available settings are:

- [Power Off] Leaves the computer in the power off state.
- [Power On] Leaves the computer in the power on state.
- [Last State] Restores the system to the previous status before power failure or interrupt occurred.

► Resume On LAN

This field specifies whether the system will be awakened from power saving modes when activity or input signal of onboard LAN is detected.

► Resume On PME#

When setting to [Enabled], this setting allows your system to be awakened from the power saving modes through any event on PME (Power Management Event).

► Resume On RTC Alarm

When [Enabled], you can set the date and time at which the RTC (real-time clock) alarm awakens the system from Suspend mode.

Exit

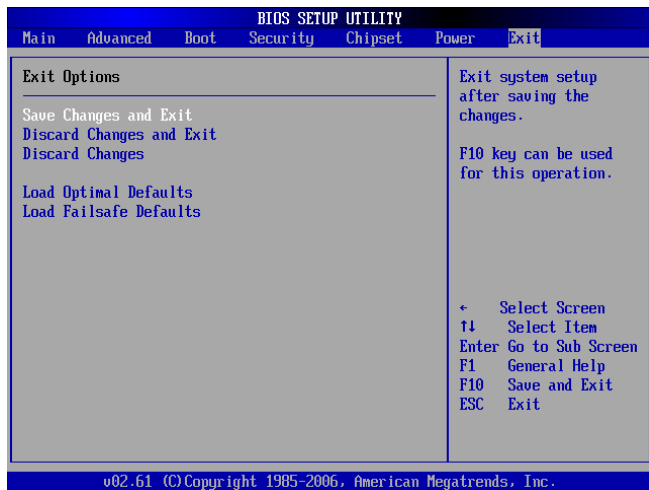

► Save Changes and Exit

Save changes to CMOS and exit the Setup Utility.

► Discard Changes and Exit

Abandon all changes and exit the Setup Utility.

► Discard Changes

Abandon all changes and continue with the Setup Utility.

► Load Optimal Defaults

Use this menu to load the default values set by the mainboard manufacturer specifically for optimal performance of the mainboard.

► Load Failsafe Defaults

Use this menu to load the default values set by the BIOS vendor for stable system performance.

Chapter 4

System Resources

This chapter provides information on the following system resources:

1. Watch Dog Timer Setting (p.4-2);
2. AMI POST Code (p.4-3);
3. Resource List (p.4-7).

Watch Dog Timer Setting

Software Code

SIO_IDX equ 4EH

SIO_DTA equ 4FH

Timer equ 10; reset after 10 seconds

1. Enter configuration mode

```
Mov      dx, SIO_IDX
mov      al, 87h
out      dx, al
out      dx, al
```

2. Set to LDN 07

```
Mov      dx, SIO_IDX
mov      al, 07h
out      dx, al
mov      dx, SIO_DTA
mov      al, 07h
out      dx, al
```

3. Set WatchDog Timer

```
Mov      dx, SIO_IDX
mov      al, 0f6h
out      dx, al
mov      dx, SIO_DTA
mov      al, Timer
out      dx, al
```

4. Exit configuration mode

```
Mov      dx, SIO_IDX
mov      al, 0AAh
out      dx, al
```

AMI POST Code

Bootblock Recovery Code Checkpoints

The Bootblock recovery code gets control when the BIOS determines that a BIOS recovery needs to occur because the user has forced the update or the BIOS checksum is corrupt. The following table describes the type of checkpoints that may occur during the Bootblock recovery portion of the BIOS:

Checkpoint	Description
E0	Initialize the floppy controller in the super I/O. Some interrupt vectors are initialized. DMA controller is initialized. 8259 interrupt controller is initialized. L1 cache is enabled.
E9	Set up floppy controller and data. Attempt to read from floppy.
EA	Enable ATAPI hardware. Attempt to read from ARMD and ATAPI CDROM.
EB	Disable ATAPI hardware. Jump back to checkpoint E9.
EF	Read error occurred on media. Jump back to checkpoint EB.
E9 or EA	Determine information about root directory of recovery media.
F0	Search for pre-defined recovery file name in root directory.
F1	Recovery file not found.
F2	Start reading FAT table and analyze FAT to find the clusters occupied by the recovery file.
F3	Start reading the recovery file cluster by cluster.
F5	Disable L1 cache.
FA	Check the validity of the recovery file configuration to the current configuration of the flash part.
FB	Make flash write enabled through chipset and OEM specific method. Detect proper flash part. Verify that the found flash part size equals the recovery file size.
F4	The recovery file size does not equal the found flash part size.
FC	Erase the flash part.
FD	Program the flash part.
FF	The flash has been updated successfully. Make flash write disabled. Disable ATAPI hardware. Restore CPUID value back into register. Give control to F000 ROM at F000:FFF0h.

POST Code Checkpoints

The POST code checkpoints are the largest set of checkpoints during the BIOS pre-boot process. The following table describes the type of checkpoints that may occur during the POST portion of the BIOS:

Checkpoint	Description
03	Disable NMI, Parity, video for EGA, and DMA controllers. Initialize BIOS, POST, Runtime data area. Also initialize BIOS modules on POST entry and GPNV area. Initialized CMOS as mentioned in the Kernel Variable "wCMOSFlags."
04	Check CMOS diagnostic byte to determine if battery power is OK and CMOS checksum is OK. Verify CMOS checksum manually by reading storage area. If the CMOS checksum is bad, update CMOS with power-on default values and clear passwords. Initialize status register A. Initializes data variables that are based on CMOS setup questions. Initializes both the 8259 compatible PICs in the system
05	Initializes the interrupt controlling hardware (generally PIC) and interrupt vector table.
06	Do R/W test to CH-2 count reg. Initialize CH-0 as system timer. Install the POSTINT1Ch handler. Enable IRQ-0 in PIC for system timer interrupt. Traps INT1Ch vector to "POSTINT1ChHandlerBlock."
08	Initializes the CPU. The BAT test is being done on KBC. Program the keyboard controller command byte is being done after Auto detection of KB/MS using AMI KB-5.
0A	Initializes the 8042 compatible Key Board Controller.
0B	Detects the presence of PS/2 mouse.
0C	Detects the presence of Keyboard in KBC port.
0E	Testing and initialization of different Input Devices. Also, update the Kernel Variables. Traps the INT09h vector, so that the POST INT09h handler gets control for IRQ1. Uncompress all available language, BIOS logo, and Silent logo modules.

Checkpoint	Description
13	Early POST initialization of chipset registers.
24	Uncompress and initialize any platform specific BIOS modules.
30	Initialize System Management Interrupt.
2A	Initializes different devices through DIM. See <i>DIM Code Checkpoints</i> section of document for more information.
2C	Initializes different devices. Detects and initializes the video adapter installed in the system that have optional ROMs.
2E	Initializes all the output devices.
31	Allocate memory for ADM module and uncompress it. Give control to ADM module for initialization. Initialize language and font modules for ADM. Activate ADM module.
33	Initializes the silent boot module. Set the window for displaying text information.
37	Displaying sign-on message, CPU information, setup key message, and any OEM specific information.
38	Initializes different devices through DIM. See <i>DIM Code Checkpoints</i> section of document for more information.
39	Initializes DMAC-1 & DMAC-2.
3A	Initialize RTC date/time.
3B	Test for total memory installed in the system. Also, Check for DEL or ESC keys to limit memory test. Display total memory in the system.
3C	Mid POST initialization of chipset registers.
40	Detect different devices (Parallel ports, serial ports, and coprocessor in CPU, ... etc.) successfully installed in the system and update the BDA, EBDA...etc.
50	Programming the memory hole or any kind of implementation that needs an adjustment in system RAM size if needed.
52	Updates CMOS memory size from memory found in memory test. Allocates memory for Extended BIOS Data Area from base memory.
60	Initializes NUM-LOCK status and programs the KBD typematic rate.
75	Initialize Int-13 and prepare for IPL detection.
78	Initializes IPL devices controlled by BIOS and option ROMs.
7A	Initializes remaining option ROMs.
7C	Generate and write contents of ESCD in NVRam.
84	Log errors encountered during POST.
85	Display errors to the user and gets the user response for error.
87	Execute BIOS setup if needed / requested.
8C	Late POST initialization of chipset registers.
8E	Program the peripheral parameters. Enable/Disable NMI as selected
90	Late POST initialization of system management interrupt.
A0	Check boot password if installed.
A1	Clean-up work needed before booting to OS.
A2	Takes care of runtime image preparation for different BIOS modules. Fill the free area in F000h segment with 0FFh.

MS-9830 Mainboard

	Initializes the Microsoft IRQ Routing Table. Prepares the runtime language module. Disables the system configuration display if needed.
A4	Initialize runtime language module.
A7	Displays the system configuration screen if enabled. Initialize the CPU's before boot, which includes the programming of the MTRR's.
A8	Prepare CPU for OS boot including final MTRR values.
A9	Wait for user input at config display if needed.
AA	Uninstall POST INT1Ch vector and INT09h vector. Deinitializes the ADM module.
AB	Prepare BBS for Int 19 boot.
AC	End of POST initialization of chipset registers.
B1	Save system context for ACPI.
00	Passes control to OS Loader (typically INT19h).

Resource List

ICH7M GPIO

Pin	GPIO	Type	Multiplexed with	Power	Connect
AB18	GPIO0	I/O	BM_BUSY#	VCC3	PM_BMBUSY#
C8	GPIO1	I/O	REQ[5]#	VCC5	PREQ#5
G8	GPIO2	I/OD	PIRQE#	VCC5	VCC3
F7	GPIO3	I/OD	PIRQF#	VCC5	VCC3
F8	GPIO4	I/OD	PIRQG#	VCC5	VCC3
G7	GPIO5	I/OD	PIRQH#	VCC5	VCC3
AC21	GPIO6	I/O	Unmultiplexed	VCC3	ATADET0
AC18	GPIO7	I/O	Unmultiplexed	VCC3	SIO_OVT#
E21	GPIO8	I/O	Unmultiplexed	3VSB	3VSB
E20	GPIO9	I/O	Unmultiplexed	3VSB	3VSB
A20	GPIO10	I/O	Unmultiplexed	3VSB	3VSB
B23	GPIO11	I/O	SMBALERT#	3VSB	SMBALERT#
F19	GPIO12	I/O	Unmultiplexed	3VSB	SPI_HOLD_GPO#
E19	GPIO13	I/O	Unmultiplexed	3VSB	SIO_PME#
R4	GPIO14	I/O	Unmultiplexed	3VSB	3VSB
E22	GPIO15	I/O	Unmultiplexed	3VSB	3VSB
AC22	GPIO16	I/O	DPRSLPVR	VCC3	DPRSLPVR
D8	GPIO17	I/O	GNT5#	VCC3	PGNT#5
AC20	GPIO18	I/O	STPPCI#	VCC3	PM_STPPCI#
AH18	GPIO19	I/O	SATA1GP	VCC3	SATA1GP
AF21	GPIO20	I/O	STPCPU#	VCC3	PM_STPCPU#
AF19	GPIO21	I/O	SATA0GP	VCC3	SATA0GP
A13	GPIO22	I/O	REQ4#	VCC3	PREQ#4
AA51	GPIO23	I/O	LDRQ1#	VCC3	NC
B3	GPIO24	I/O	Unmultiplexed	3VSB	BIOS_WP#
D20	GPIO25	I/O	Unmultiplexed	3VSB	NC
A21	GPIO26	I/O	Unmultiplexed	3VSB	NC
B12	GPIO27	I/O	Unmultiplexed	3VSB	DISABLE_LAN1
E23	GPIO28	I/O	Unmultiplexed	3VSB	DISABLE_LAN2
C3	GPIO29	I/O	OC5#	3VSB	3VSB

MS-9830 Mainboard

Pin	GPIO	Type	Multiplexed with	Power	Connect
A2	GPIO30	I/O	OC6#	3VSB	3VSB
B3	GPIO31	I/O	OC7#	3VSB	3VSB
AG18	GPIO32	I/O	CLKRUN#	VCC3	CLKRUN#
AC19	GPIO33	I/O	AZ_DOCK_EN#	VCC3	PRES2
U2	GPIO34	I/O	AZ_DOCK_RST#	VCC3	PRES3
AD21	GPIO35	I/O	SATACLKREQ#	VCC3	PRES1
AH19	GPIO36	I/O	SATA2GP	VCC3	SATA2GP
AE19	GPIO37	I/O	SATA3GP	VCC3	SATA3GP
AD20	GPIO38	I/O	Unmultiplexed	VCC3	NC
AE20	GPIO39	I/O	Unmultiplexed	VCC3	WLAN_PWRON
A14	GPIO48	I/O	GNT4#	VCC3	PGNT#4
AG24	GPIO49	I/O	CPUPERGD	VTT	CPU_PWRGD

SIO GPIO

Pin	GPIO	Type	Multi	Power	Default	Connection
49	GPIO0	I/OOD	VIDOUT0	VSB	VIDOUT0	NC
50	GPIO1	I/OOD	VIDOUT1	VSB	VIDOUT1	NC
51	GPIO2	I/OOD	VIDOUT2	VSB	VIDOUT2	NC
52	GPIO3	I/OOD	VIDOUT3	VSB	VIDOUT3	NC
53	GPIO4	I/OOD	VIDOUT4	VSB	VIDOUT4	NC
54	GPIO5	I/OOD	VIDOUT5 / SIC	VSB	VIDOUT5	NC
55	GPIO6	I/OOD	SLOT0CC#	VSB	SLOT0CC#	SKTOCC#
56	GPIO7	I/OOD	Turbo1#/ WDTRST#	VSB	GPI	WDT#
59	GPIO10	I/OOD	SPL_SLK/FANIN4	VSB	GPI	EN232
60	GPIO11	I/OOD	SPL_CS0#/ FANCTL4	VSB	GPI	#EN485
61	GPIO12	I/OOD	SPL_MISO/ FANCTL1_1	VSB	GPI	#EN422
62	GPIO13	I/OOD	SPL_MOSI/ BEEP	VSB	GPI	BEEP
63	GPIO14	I/OOD	FWH_DIS/WDTRST#/ SPL_CS1#	VSB	GPI	AMP_EN
64	GPIO15	I/OOD	LED_VSB/ ALERT#	VSB	GPI	LED_VSB
65	GPIO16	I/OOD	LED_VCC/ Turbo2#	VSB	GPI	LED_VCC
66	GPIO17	I/OOD	Unmultiplexed	VSB	GPI	FAN_12V_SET#
74	GPIO20	I/OOD	PCIRST1#	VSB	PCIRST1#	PLTRST_BU#1
75	GPIO21	I/OOD	PCIRST2#	VSB	PCIRST2#	PLTRST_BU#2
76	GPIO22	I/OOD	PCIRST3#	VSB	PCIRST3#	PLTRST_BU#3
77	GPIO23	I/OOD	RSTCON#	VSB	GPIO	NC
78	GPIO24	I/OOD	ATXPG_IN	VSB	ATXPG_IN	ATX_PWR_OK
79	GPIO25	I/OOD	PME#	VSB	PME#	SIO_PME#
80	GPIO26	I/OOD	PWSIN#	VSB	PWSIN#	PSIN
81	GPIO27	I/OOD	PWSOUT#	VSB	PWSOUT#	PSOUT#
82	GPIO30	I/OOD	S3#	VSB	S3#	SLP_S3#
83	GPIO31	I/OOD	PSON#	VSB	PSON#	PS_ON#
84	GPIO32	I/OOD	PWROK	VSB	PWROK	NC
85	GPIO33	I/OOD	RSMRST#	VBAT	RSMRST#	RSMRST#
25	GPIO40	I/OOD	FANIN3	VCC	FANIN3	AMP_GAIN0
26	GPIO41	I/OOD	FAN_CTL3	VCC	FAN_CTL3	SYS_FANOUT1
27	GPIO42	I/OOD	IRTX	VCC	IRTX	NC
28	GPIO43	I/OOD	IRRX	VSB	IRRX	AMP_GAIN1